



4K ULTRA HD

HDBaseT™ Extender w/ RS-232, 2-way IR, and POH

GTB-UHD-HBT2

User Manual



Release A1

Important Safety Instructions

1. Read these instructions.
2. Keep these instructions.
3. Heed all warnings.
4. Follow all instructions.
5. Do not use this product near water.
6. Clean only with a dry cloth.
7. Do not block any ventilation openings. Install in accordance with the manufacturer's instructions.
8. Do not install or place this product near any heat sources such as radiators, heat registers, stoves, or other apparatus (including amplifiers) that produce heat.
9. Do not defeat the safety purpose of the polarized or grounding-type plug. A polarized plug has two blades with one wider than the other. A grounding type plug has two blades and a third grounding prong. The wide blade or the third prong are provided for your safety. If the provided plug does not fit into your outlet, consult an electrician for replacement of the obsolete outlet.
10. Protect the power cord from being walked on or pinched particularly at plugs, convenience receptacles, and the point where they exit from the apparatus.
11. Only use attachments/accessories specified by the manufacturer.
12. To reduce the risk of electric shock and/or damage to this product, never handle or touch this unit or power cord if your hands are wet or damp. Do not expose this product to rain or moisture.
13. Unplug this apparatus during lightning storms or when unused for long periods of time.
14. Refer all servicing to qualified service personnel. Servicing is required when the apparatus has been damaged in any way, such as power-supply cord or plug is damaged, liquid has been spilled or objects have fallen into the apparatus, the apparatus has been exposed to rain or moisture, does not operate normally, or has been dropped.
15. Batteries that may be included with this product and/or accessories should never be exposed to open flame or excessive heat. Always dispose of used batteries according to the instructions.

Warranty Information

Gefen warrants the equipment it manufactures to be free from defects in material and workmanship.

If equipment fails because of such defects and Gefen is notified within two (2) years from the date of shipment, Gefen will, at its option, repair or replace the equipment, provided that the equipment has not been subjected to mechanical, electrical, or other abuse or modifications. Equipment that fails under conditions other than those covered will be repaired at the current price of parts and labor in effect at the time of repair. Such repairs are warranted for ninety (90) days from the day of reshipment to the Buyer.

This warranty is in lieu of all other warranties expressed or implied, including without limitation, any implied warranty or merchantability or fitness for any particular purpose, all of which are expressly disclaimed.

1. Proof of sale may be required in order to claim warranty.
2. Customers outside the US are responsible for shipping charges to and from Gefen.
3. Copper cables are limited to a 30 day warranty and cables must be in their original condition.

The information in this manual has been carefully checked and is believed to be accurate. However, Gefen assumes no responsibility for any inaccuracies that may be contained in this manual. In no event will Gefen be liable for direct, indirect, special, incidental, or consequential damages resulting from any defect or omission in this manual, even if advised of the possibility of such damages. The technical information contained herein regarding the features and specifications is subject to change without notice.

For the latest warranty coverage information, refer to the Warranty and Return Policy under the Support section of the Gefen Web site at www.gefen.com.

Technical Support

(818) 772-9100 (800) 545-6900
8:00 AM to 5:00 PM Monday - Friday, Pacific Time

Fax

(818) 772-9120

Email

support@gefen.com

Web

<http://www.gefen.com>

Mailing Address

Gefen, LLC
c/o Customer Service
20600 Nordhoff St.
Chatsworth, CA 91311

Product Registration

Register your product here: <http://www.gefen.com/kvm/Registry/Registration.jsp>

- The Gefen Syner-G Software Suite is a free downloadable application from Gefen that provides automatic download and installation of firmware upgrades as well as EDID management.

Download the application here: <http://www.gefen.com/synerg>

4K Ultra HD HDBaseT™ Extender w/ RS-232, 2-way IR, and POH is a trademark of Gefen, LLC.

© 2016 Gefen, LLC. All Rights Reserved. All trademarks are the property of their respective owners.

Gefen, LLC reserves the right to make changes in the hardware, packaging, and any accompanying documentation without prior written notice.



This product uses UL listed or CE-compliant power supplies.

Features and Packing List

Features

- Extends HDMI, RS-232, and 2-way IR over a single CAT-5e
 - ▶ 4K Ultra HD (3840 x 2160 @ 60Hz, 4:2:0, 8-bit), up to 330 feet/100 meters
 - ▶ 4K Ultra HD (3840 x 2160 @ 30Hz, 4:4:4, 8-bit), up to 330 feet/100 meters
 - ▶ 4K DCI-Cinema (4096 x 2160 @ 30Hz 4:4:4, 8-bit), up to 330 feet/100 meters
 - ▶ 1080p Full HD (1920 x 1080 @ 60Hz, 4:4:4, 12-bit), up to 330 feet/100 meters
 - ▶ 1080p Full HD (1920 x 1080 @ 60Hz, 4:4:4, 8-bit), up to 495 feet/150 meters
 - ▶ WUXGA (1920 x 1200 @ 60Hz, 8-bit), up to 495 feet/150 meters
- HDMI Features Supported:
 - ▶ HDMI 2.0 up to 4K 60Hz, 4:2:0, 8-bit color
 - ▶ HDCP 2.2 and 1.4
 - ▶ 12-bit Deep Color
 - ▶ LPCM 7.1 audio, Dolby Atmos®, Dolby® TrueHD, DTS:X™, and DTS-HD Master Audio™ pass-through
 - ▶ 3DTV pass-through
 - ▶ CEC pass-through
 - ▶ Lip Sync pass-through
- IR extension from Sender to Receiver and from Receiver to Sender
- POH (Power Over HDBaseT™) feature provides power to the Receiver unit over the link cable - only the Sender unit needs external power
- Advanced EDID Management via Gefen Syner-G™ software
- Link Quality Monitoring via Gefen Syner-G™ software
- In-field firmware update via USB, using Gefen Syner-G™ software
- Locking power connector
- Low profile, surface-mountable enclosures

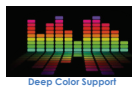

Packing List

The 4K Ultra HD HDBaseT Extender w/ RS-232, 2-way IR, and POH ships with the items listed below. The packing contents of the Sender and Receiver unit are listed below. If any of these items are not present in the box when you first open it, immediately contact your dealer or Gefen.

- 1 x 4K Ultra HD HDBaseT™ Extender w/ RS-232, 2-way IR, and POH (Sender)
- 1 x 4K Ultra HD HDBaseT™ Extender w/ RS-232, 2-way IR, and POH (Receiver)
- 1 x IR emitter
- 1 x IR extender
- 1 x DB-9 cable (M-F)
- 1 x 48V DC locking power supply
- 1 x Quick-Start Guide

1 Getting Started

Introduction.....	2
Sender Unit	2
Receiver Unit.....	4
Installation	6
Connection Instructions.....	6
Application Diagram	7

2 Basic Operation

DIP Switch Configuration	10
Sender unit.....	10
Receiver unit.....	13
Notes on IR Carrier Signals	14
LED Status	15
Bidirectional IR Control.....	16
Controlling the Source from the Viewing Location	16
Controlling the Display from the Source Location	17
Controlling the Source / Display from Different Locations.....	18
RS-232 Interface	19
RS-232 Interface	19

3 Advanced Operation

Using Syner-G™	24
Verifying the USB Driver	24
Downloading an EDID.....	26
Uploading an EDID	29
Copying an EDID	31
Viewing an EDID	33

4 Appendix

Updating the Firmware.....	40
Default Settings.....	46
Sender Unit DIP Switches.....	46
Receiver Unit DIP Switches	46
Network Cable Diagram	47
Specifications	48
Index.....	49

This page left intentionally blank.

This page left intentionally blank.

4K ULTRA  **HD**

HDBaseT™ Extender

w/ RS-232, 2-way IR, and POH

1

Getting Started

Sender Unit

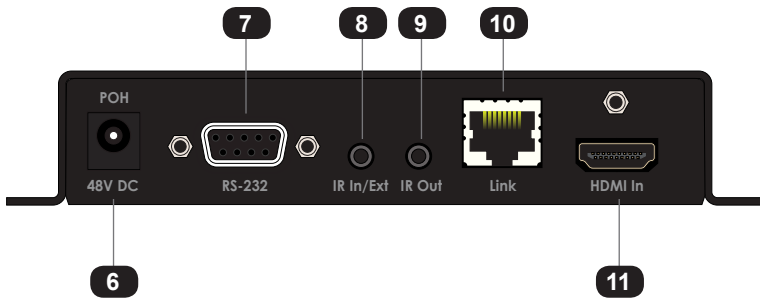
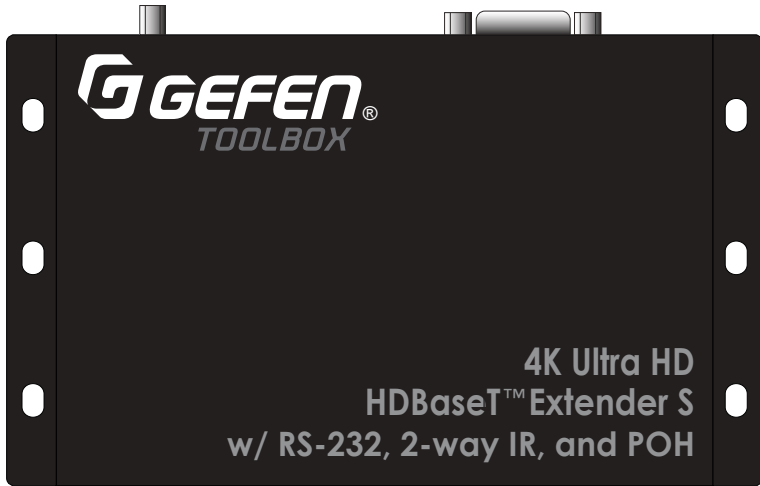
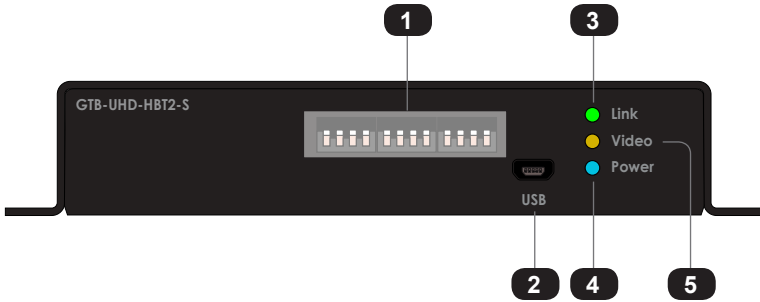

ID	Name	Description
1	DIP switches	See DIP Switch Configuration (page 10) for more information.
2	USB	For use with the Syner-G Software Suite. See Using Syner-G™ (page 24) for more information.
3	Link (LED)	This LED indicator glows solid green when the Sender and Receiver unit are connected by a CAT-5 (or better) cable.
4	Power	This LED indicator glows solid blue when the Sender unit is powered.
5	Video	This LED indicator glows solid amber when HDCP content is detected. If Non-HDCP content is detected, then this LED indicator will flash amber.
6	POH 48V DC	Connect the included 48V DC power supply to this connector.
7	RS-232	Connect the included RS-232 cable from this port to an automation device. See RS-232 Interface (page 19) for more information.
8	IR In / Ext	Connect an IR extender (Gefen part no. EXT-RMT-EXTIRN) to this port.
9	IR Out	Connect an IR emitter (Gefen part no. EXT-2IREMIT) to this port.
10	Link	Connect a CAT-5 (or better) cable from this port to the Link port on the Receiver unit.
11	HDMI In	Connect a 4K Ultra HD source to this HDMI port using an HDMI cable.

Receiver Unit

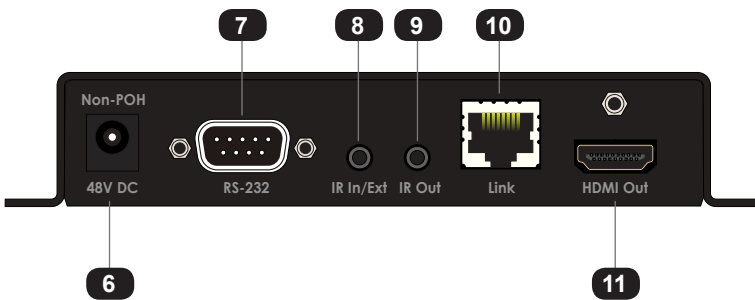
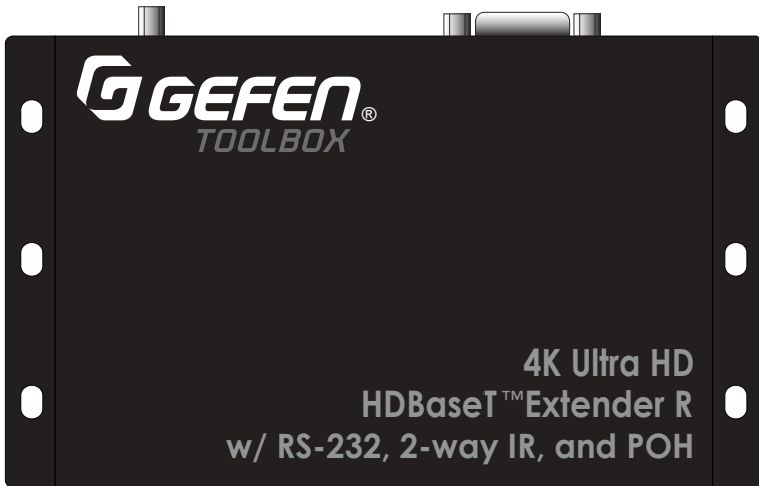
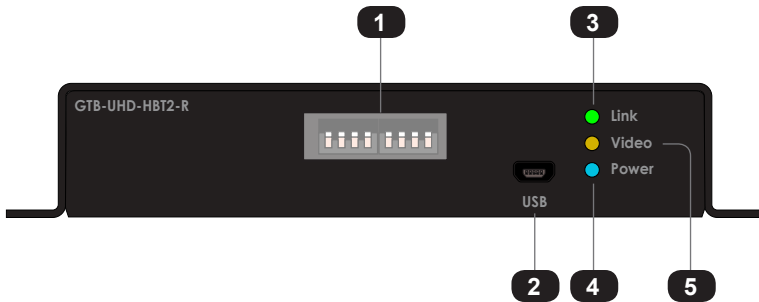

ID	Name	Description
1	DIP switches	See DIP Switch Configuration (page 10) for more information.
2	USB	For use with the Syner-G Software Suite. See Using Syner-G™ (page 24) for more information.
3	Link (LED)	This LED indicator glows solid green when the Sender and Receiver unit are connected by a CAT-5 (or better) cable.
4	Power	This LED indicator glows solid blue when the Sender unit is powered.
5	Video	This LED indicator glows solid amber when HDCP content is detected. If Non-HDCP content is detected, then this LED indicator will flash amber.
6	Non-POH 48V DC	Use this port only when using a HDBaseT-compatible device as the Sender.
7	RS-232	Connect the included RS-232 cable from this port to an automation device. See RS-232 Interface (page 19) for more information.
8	IR In / Ext	Connect an IR extender (Gefen part no. EXT-RMT-EXTIRN) to this port.
9	IR Out	Connect an IR emitter (Gefen part no. EXT-IREMIT) to this port.
10	Link	Connect a CAT-5 (or better) cable from this port to the Link port on the Receiver unit.
11	HDMI In	Connect a 4K Ultra HD source to this HDMI port using an HDMI cable.

Connection Instructions

▶ Video

1. Connect the included HDMI cable from the 4K Ultra HD source to the **HDMI In** port on the Sender unit.
2. Connect an HDMI cable from the **HDMI Out** port on the Receiver unit to the 4K Ultra HD display.

▶ Link

3. Connect a shielded CAT-5e (or better) cable from the **Link** port on the Sender unit to the **Link** port on the Receiver unit.

Maximum Resolution	Mode	Distance
1920 x 1080p 60 Hz @ 8-bit	Long Reach mode	495 feet (150 meters)
3840 x 2160p 60 Hz @ 4:2:0	Normal mode	330 feet (100 meters)

See [DIP Switch Configuration \(page 10\)](#) for more information on setting the extension distance.

▶ IR Control - see [Bidirectional IR Control \(page 16\)](#) for more information

4. Connect the included IR emitter to the **IR Out** port on the Sender unit.
5. Connect the included IR extender to the **IR In/Ext** port on the Receiver unit.

▶ RS-232 - see [RS-232 Interface \(page 19\)](#) for more information

6. Connect the included DB-9 cable from the automation device to the **RS-232** port on the Sender unit
7. Connect a DB-9 cable from the **RS-232** port on the Receiver unit to the RS-232 device to be controlled.

▶ Power

8. Connect the included power supply to the **POH 48V DC** connector on the Sender unit.

Application Diagram

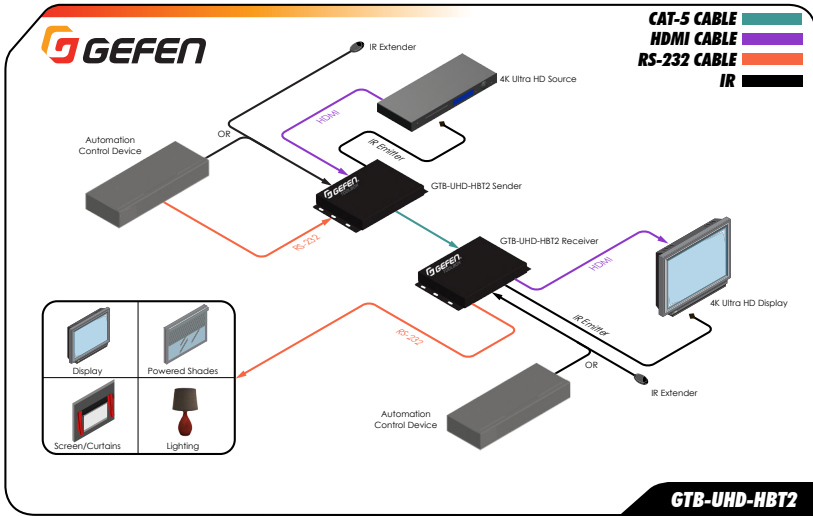

This page left intentionally blank.

4K ULTRA  **HD**

HDBaseT™ Extender

w/ RS-232, 2-way IR, and POH

2 Basic Operation

Sender unit

The back panel of the Sender unit contains three banks of DIP switches. Each bank contains four DIP switches. These DIP switches control EDID, HPD, HDCP, IR, and HDBT mode. The *default* setting, for each DIP switch, is in the “down” (OFF) position.

Each DIP switch (1 - 12) is arranged from left to right. DIP switches 11 and 12 are not used. Although the DIP switch numbers do not appear on the unit, we have included them for easy reference.

If a DIP switch is in the “up” position, then it is ON. If a DIP switch is in the “down” position, then it is OFF.

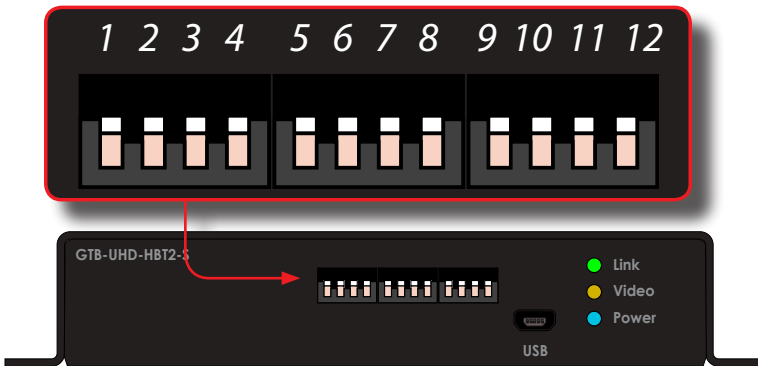

DIP	Feature	Description
1	Local / pass-through EDID	<ul style="list-style-type: none"> ▶ ON Allows all video and audio features of the connected device to be passed to the source device. ▶ OFF (default) Copies the downstream EDID locally in HDBT mode; modifies downstream EDID to support only up to 1080p60 8-bit in Long Reach mode.
2	Hot-Plug Detect	<ul style="list-style-type: none"> ▶ ON HPD pass-through. HPD will toggle, depending on the HPD status of the display (sink) or source device. ▶ OFF (default) HPD is <i>always</i> high, even when the display is hot-plugged (disconnected from then reconnected to the source device).

DIP	Feature	Description
3	EDID Lock	<ul style="list-style-type: none"> ▶ ON EDID Lock <i>enabled</i>. The current EDID will be stored on the input even if the unit is power-cycled. ▶ OFF (default) EDID Lock <i>disabled</i>.
4	HDCP Control	<ul style="list-style-type: none"> ▶ ON Prevents HDCP content from passing through to the display (sink) device. ▶ OFF (default) Allows HDCP content to pass through to the display (sink) device.
5	Sender unit IR carrier	<ul style="list-style-type: none"> ▶ ON IR carrier signal is stripped at the Sender unit. ▶ OFF (default) IR carrier signal is passed-through.
6	Receiver unit IR carrier	<ul style="list-style-type: none"> ▶ ON IR carrier signal is stripped at the Receiver unit. ▶ OFF (default) IR carrier signal is passed-through.
7	IR Polarity	<ul style="list-style-type: none"> ▶ ON Set to work with third-party IR extenders. ▶ OFF (default) Operates with Gefen part no. EXT-RMT-EXTIRN.
8	Long-Reach Mode	<ul style="list-style-type: none"> ▶ ON Resolutions up to 1080p 60 Hz can be extended to a maximum distance of 495 feet (150 meters). Color depth is limited to 8-bit. ▶ OFF (default) HDBT mode. Resolutions up to 3840 x 2160p 60 Hz @ 4:2:0, can be extended up to 330 feet (100 meters).

DIP	Feature	Description
9	IR Carrier Frequency	<ul style="list-style-type: none">▶ ON 56 kHz.▶ OFF (default) 38 kHz.
10	IR Carrier Frequency	<ul style="list-style-type: none">▶ ON 47 kHz.▶ OFF (default) Depends upon setting of DIP 9.
11	N/A	--
12	N/A	--

Receiver unit

The back panel of the Receiver unit contains three banks of DIP switches. Each bank contains four DIP switches. The *default* setting, for each DIP switch, is in the “down” (OFF) position.

Each DIP switch (1 - 12) is arranged from left to right. DIP switch 7 and 8 are not used. Although the DIP switch numbers do not appear on the unit, we have included them for easy reference.

If a DIP switch is in the “up” position, then it is ON. If a DIP switch is in the “down” position, then it is OFF.

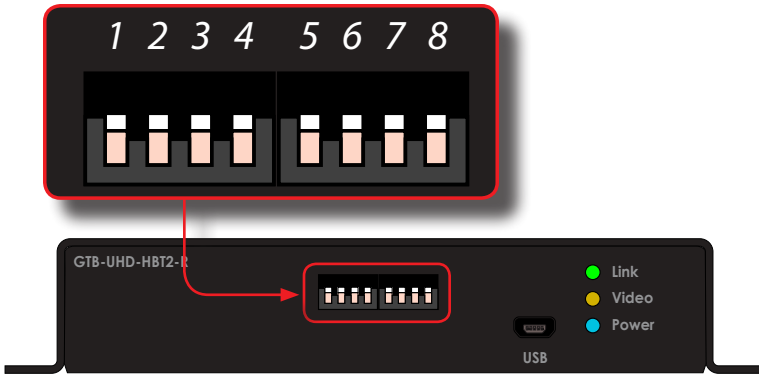

DIP	Feature	Description
1	IR Carrier Frequency	<ul style="list-style-type: none"> ▶ ON IR carrier signal is stripped at the Sender unit. ▶ OFF (default) IR carrier signal is passed-through.
2	IR Carrier Frequency	<ul style="list-style-type: none"> ▶ ON IR carrier signal is stripped at the Receiver unit. ▶ OFF (default) IR carrier signal is passed-through.
3	IR Polarity	<ul style="list-style-type: none"> ▶ ON Set to work with third-party IR extenders. ▶ OFF (default) Operates with Gefen part no. EXT-RMT-EXTIRN.

DIP	Feature	Description
4	Long-Reach Mode	<ul style="list-style-type: none"> ▶ ON Resolutions up to 1080p Full HD can be extended to a maximum distance of 495 feet (150 meters). Color depth is limited to 8-bit. ▶ OFF (default) HDBT mode. Resolutions up to 4K x 2K, can be extended up to 330 feet (100 meters) with deep color (4:2:0).
5	IR Carrier Frequency	<ul style="list-style-type: none"> ▶ ON 56 kHz. ▶ OFF (default) 38 kHz.
6	IR Carrier Frequency	<ul style="list-style-type: none"> ▶ ON 47 kHz. ▶ OFF (default) Depends upon setting of DIP 5.
7	N/A	--
8	N/A	--

Notes on IR Carrier Signals

When an IR carrier frequency is passed through from the Sender unit to the Receiver unit, or from the Receiver unit to the Sender unit, the carrier signal is not renewed. Any carrier frequency between 30 kHz and 60 kHz is natively passed through.





If the IR carrier signal is stripped at the Sender unit and added at the Receiver unit (or vice versa), then the carrier signal can be set to 38 kHz, 47 kHz, or 56 kHz.

To set the carrier signal frequency on the Sender unit, set DIP switch 5 on the Sender unit to the OFF position and use DIP switches 9 and 10 (Sender) to set the carrier frequency. To set the carrier signal frequency on the Receiver unit, set DIP switch 1 on the Receiver unit to the OFF position and use DIP switches 5 and 6 (Receiver) to set the carrier frequency.

Stripping the IR carrier signal is commonly used when directly connecting an IR cable from the output of one device to the input on another IR device.

The **Link, Video, and Power** LED indicators provides basic information on the current status of the this product.

The information, in the table below, applies to both the Sender and Receiver unit.

LED	Status	Description
Link	 Solid green	<ul style="list-style-type: none">The Sender / Receiver unit is powered.Link integrity between Sender and Receiver unit is good.
	 Flashing amber	<ul style="list-style-type: none">Non-HDCP content is detected.
Video	 Solid amber	<ul style="list-style-type: none">HDCP content is detected
	 Flashing amber	<ul style="list-style-type: none">Non-HDCP content is detected.
Power	 Solid blue	<ul style="list-style-type: none">The Sender / Receiver unit is powered.

Controlling the Source from the Viewing Location

1. Connect an IR extender (Gefen part no. EXT-RMT-EXTIRN) to the **IR In/Ext** port on the Receiver unit. If using an automation system, connect the 3.5mm mini-mono connector from the **IR In/Ext** port on the Receiver unit to the automation system. IR signals are transmitted over the CAT-5 cable.
2. Connect the IR emitter from the **IR Out** port, on the Sender unit, to the IR sensor window on the source device.

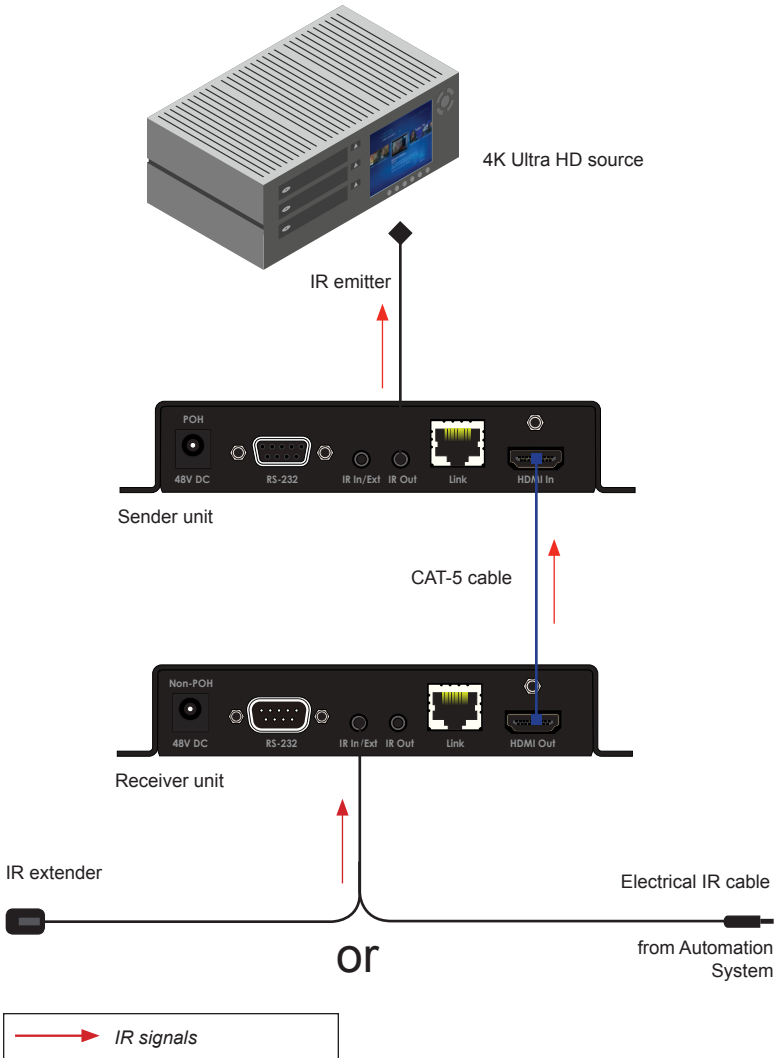

Controlling the Display from the Source Location

1. Connect an IR extender (Gefen part no. EXT-RMT-EXTIRN) to the **IR In/Ext** port on the Sender unit. If using an automation system, connect the 3.5mm mini-mono connector from the **IR In/Ext** port on the Receiver unit to the automation system. IR signals are transmitted over the CAT-5 cable.
2. Connect an IR emitter (Gefen part no. EXT-IREMIT) from the **IR Out** port on the Receiver unit to the IR sensor on the display.

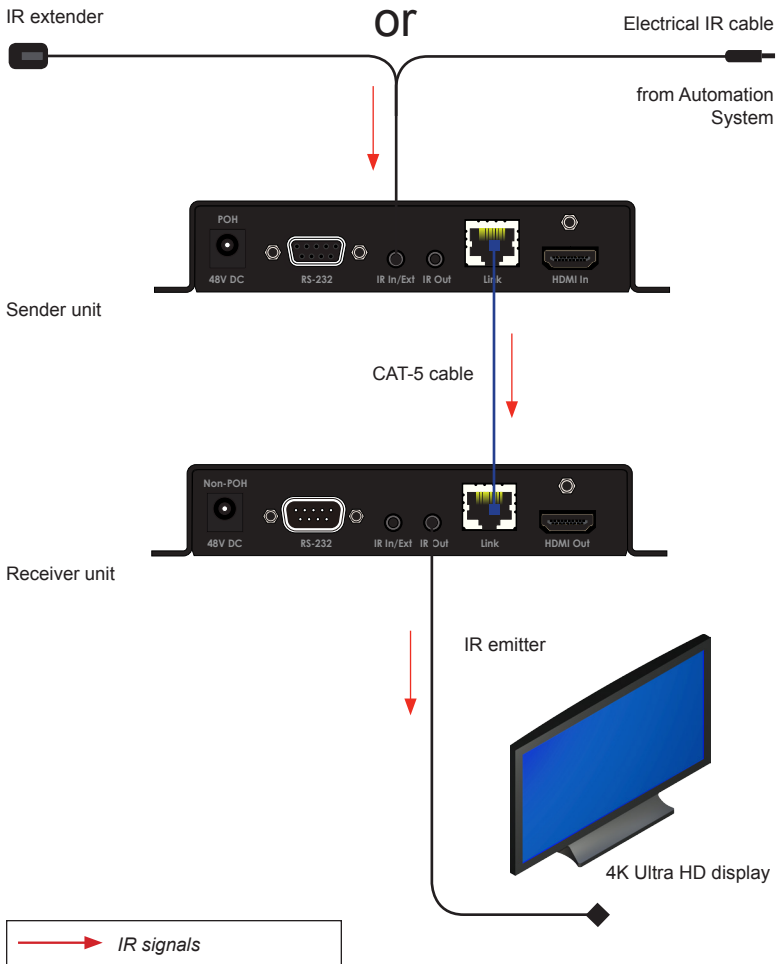

Controlling the Source / Display from Different Locations

Basic Operation

Bidirectional IR allows the source and/or display to be controlled from the Sender or Receiver unit. Refer to the diagram, below, for connection details. IR signals are transmitted over the CAT-5 cable.

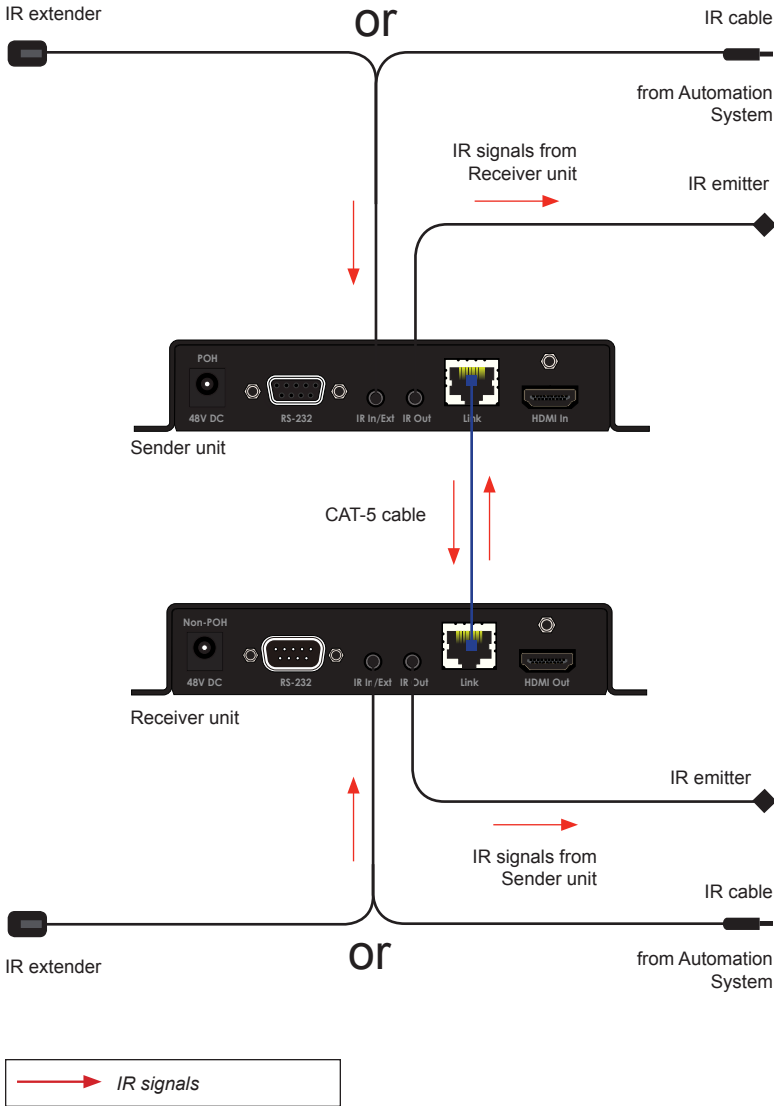

RS-232 Interface

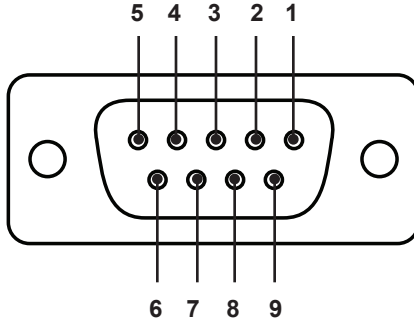

Automation Device

Extender

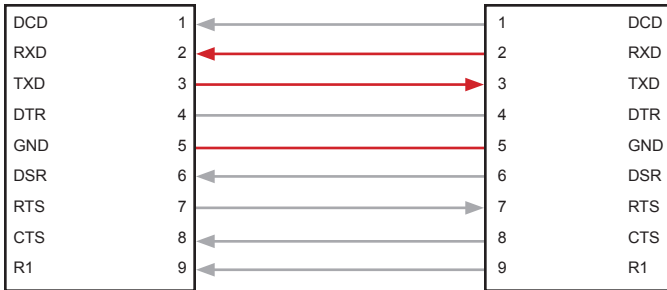

Only TXD, RXD, and GND pins are used.

This product supports RS-232 pass-through, allowing the control of remote RS-232 devices.

In the example below, an RS-232 device has been connected to the Receiver unit. Connect the automation control device to the Sender unit.

Figure 2.1 - Basic RS-232 connection

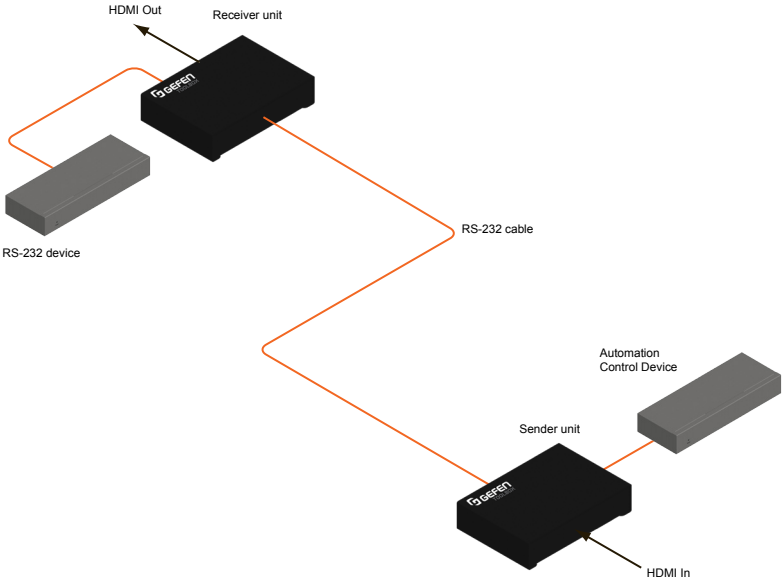

This page left intentionally blank.

This page left intentionally blank.

4K ULTRA  **HD**

HDBaseT™ Extender

w/ RS-232, 2-way IR, and POH

3

Advanced Operation

Verifying the USB Driver

In order to use this product with the Gefen Syner-G™ software, a USB driver must be installed on the computer that is running the Syner-G™ software. This driver is automatically installed when the Syner-G™ Software Suite is installed.

1. Download and install the Gefen Syner-G™ Software Suite. The Syner-G™ software can be downloaded here: <http://www.gefen.com/synerg>
2. Connect a mini-USB-to-USB cable (not included) from the **USB** port on the front of the Sender or Receiver unit to an available USB port on the computer.
3. From the Windows Desktop, click the **Start** button, select **Computer**, then right-click and select **Manage** from the context menu.

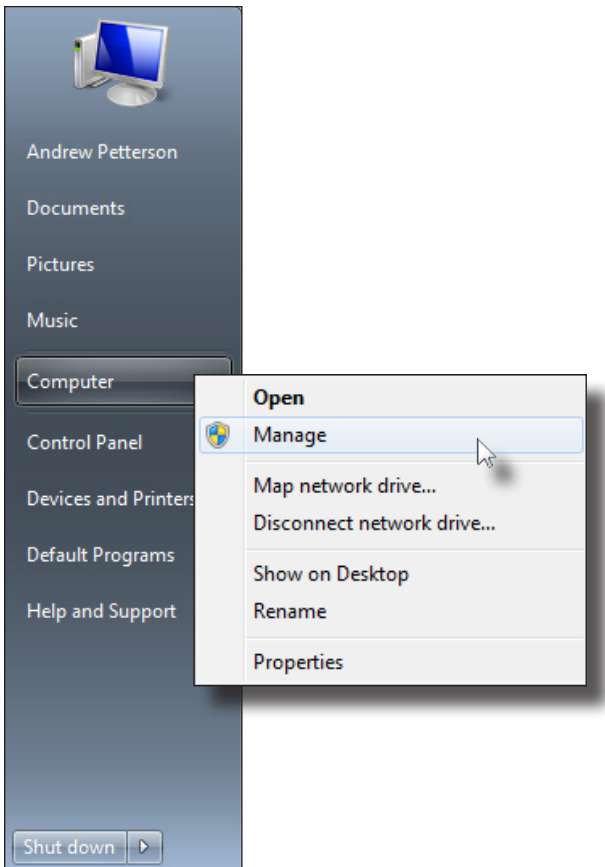

4. The **Computer Management** window will open.
5. In the left window pane, under **System Tools**, click **Device Manager**.
6. In the right window pane, locate **Ports (COM & LPT)**.

The device driver will be displayed. In this case, **GTB-UHD-HBT2-S** will be displayed. If the USB cable is connected to the Receiver unit, then the device driver will be **GTB-UHD-HBT2-R**.

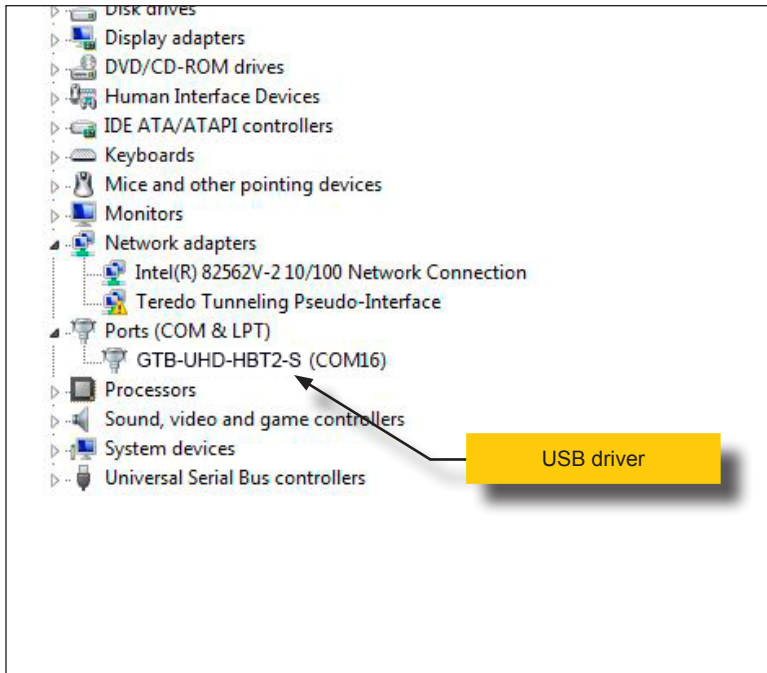

Downloading an EDID

EDID data can be downloaded from the connected Gefen Detective device to a local file. Note that the Downstream EDID or Bank EDID data cannot be downloaded to a file. To download this EDID data, it must first be copied to the Local EDID. See [Copying an EDID \(page 31\)](#) for more information on copying EDID data.

1. Click the **Manage a Product** button and select the connected product from the drop-down list.
2. Click the **Manage EDID** tab.

Select Function

Discover and Configure IP **Manage a Product** EDID Editor

Select Product GTB-UHD-HBT2-S, COM18

Status **Manage EDID** Update

Version Info

GTB_UHD_HBT2_S
Release version: 1.00
Release date: Nov 2 2015
Release time: 13:06:29

Select EDID From Device Save As View

Upload EDID to Local EDID Browse Upload

Copy EDID from Down Stream to Local EDID Copy

EDID Mode Internal Custom

- Information about the currently selected device will be displayed in the **Version Info** field.

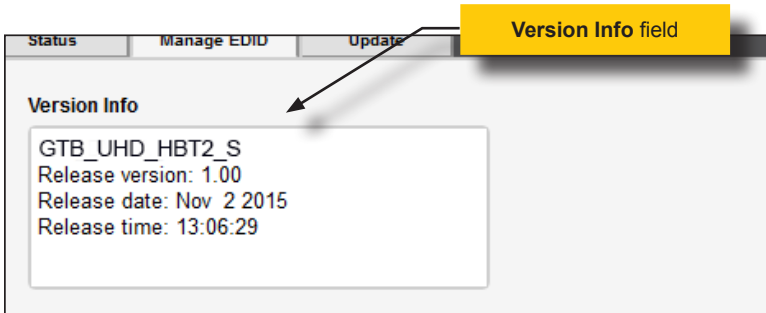

- Click the drop-down list next to the **Download** button, and select the desired EDID. In this example, we will select `Extender: Local EDID`.

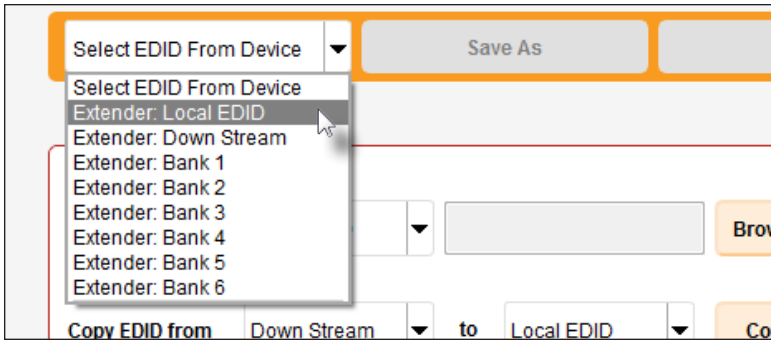

- Click the **Save As** button.



- The Windows **Save File** dialog will be displayed. Select the desired folder and specify the name of the file in the **File name** field, within the **Save File** dialog. Make sure to specify the `.bin` extension to the filename.

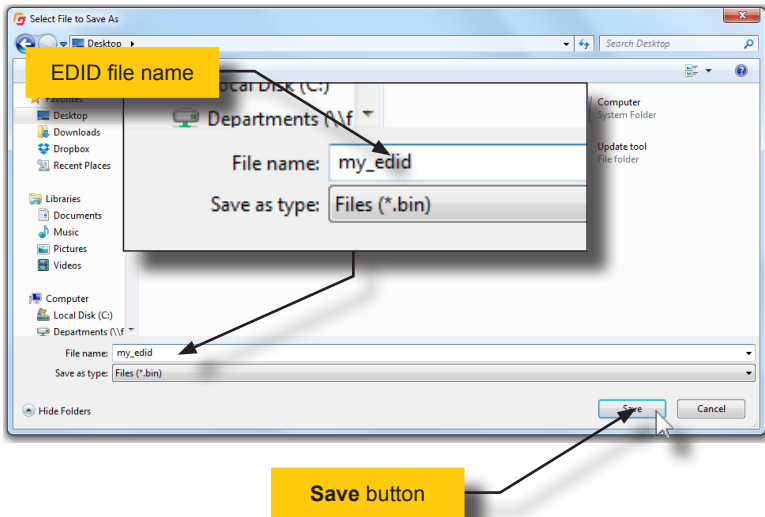

7. Click the **Save** button.

Uploading an EDID

1. Click the **Manage a Product** button and select the connected product from the drop-down list.
2. Click the **Manage EDID** tab.
3. Click the **Upload EDID to** drop-down list to select the location where the EDID will be uploaded. The EDID can be uploaded to the Local EDID or an EDID bank.

In the example below, we will select **Local EDID**.

The screenshot shows a web interface for managing EDID. At the top, there is a header bar with a dropdown menu set to 'Extender: Local EDID', a 'Save As' button, and a 'View' button. Below this, the main content area is divided into two sections. The first section, labeled 'Upload EDID to', has a dropdown menu that is currently open, showing options: 'Local EDID', 'Bank 1', 'Bank 2', 'Bank 3', 'Bank 4', 'Bank 5', and 'Bank 6'. A mouse cursor is pointing at 'Local EDID'. To the right of this dropdown is a text input field and a 'Browse' button. The second section, labeled 'Copy EDID from', has a dropdown menu set to 'Local EDID', a 'to' label, another dropdown menu set to 'Local EDID', and a 'Copy' button.

4. Click the **Browse** button.

The screenshot shows the same web interface as the previous one, but now the 'Upload EDID to' dropdown menu is closed and set to 'Local EDID'. The 'Browse' button is highlighted with a mouse cursor, indicating it is being clicked. The 'Copy EDID from' section remains the same, with the dropdown set to 'Down Stream' and the 'to' dropdown set to 'Local EDID'.

- The Windows **Select File** dialog will be displayed.
- Select the desired EDID file. The EDID file must be in `.bin` format.
- Click the **Open** button.

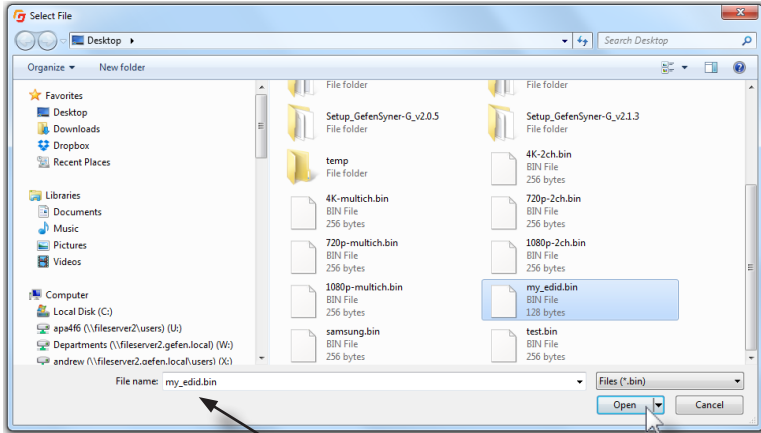

File name: `my_edid.bin`

- Click the **Upload** button.

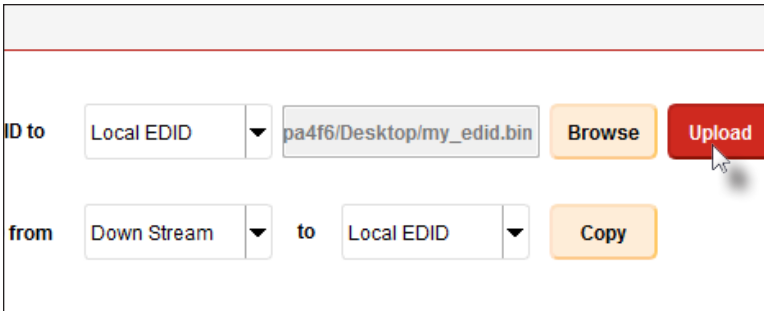

- In the lower-left corner of the interface, the “Uploading...” message will appear as the EDID is uploaded. Once the operation is complete, the “Upload Complete.” message will be displayed.

Uploading...

Upload Complete.

Copying an EDID

1. Click the **Manage a Product** button and select the connected product from the drop-down list.
2. Click the **Manage EDID** tab.
3. Click the **Copy EDID from** drop-down list to select the location from where the EDID will be copied. The EDID can be copied from any of the following locations: The downstream EDID, an EDID bank, or a default EDID location

In the example below, we will select **Down Stream**.

The screenshot shows a web interface for managing EDID. It features three main sections:

- Upload EDID to:** A dropdown menu set to 'Local EDID' with a 'Browse' button to its right.
- Copy EDID from:** A dropdown menu currently open, showing a list of options: 'Down Stream', 'Bank 1', 'Bank 2', 'Bank 3', 'Bank 4', 'Bank 5', 'Bank 6', 'Default EDID 1', 'Default EDID 2', and 'Default EDID 3'. A mouse cursor is pointing at 'Down Stream', which is highlighted. To the right of this dropdown is a 'to' label and another dropdown menu set to 'Local EDID', followed by a 'Copy' button.
- EDID Mode:** A section with a 'Custom' button.

4. Click the **Copy EDID to** drop-down list to select the location to where the EDID will be copied. The EDID can be copied to the Local EDID or to an EDID bank.

This screenshot shows the same interface as the previous one, but with the 'Copy EDID to' dropdown menu open. The options in this menu are 'Local EDID', 'Bank 1', 'Bank 2', 'Bank 3', 'Bank 4', 'Bank 5', and 'Bank 6'. A mouse cursor is pointing at 'Local EDID', which is highlighted. The 'Copy EDID from' dropdown is now closed and set to 'Down Stream'. The 'EDID Mode' section now shows an 'Internal' button instead of 'Custom'.

- Click the **Copy** button.

The screenshot shows the EDID configuration interface. It includes two rows of controls:

- Upload EDID to:** A dropdown menu set to "Local EDID", an empty text input field, and a yellow "Browse" button.
- Copy EDID from:** A dropdown menu set to "Down Stream", the word "to", another dropdown menu set to "Local EDID", and a red "Copy" button. A mouse cursor is pointing at the "Copy" button.

Below these controls is a section labeled "EDID Mode" with two buttons: "Internal" and "Custom".

- In the lower-left corner of the interface, the “Copying...” message will appear as the EDID is uploaded. The copy-result message will vary, depending upon the copy operation.



In this example, since we copied the downstream EDID to the local EDID, the “Copy result: Downstream stored to local.” message is displayed.

Viewing an EDID

1. Click the **Manage a Product** button and select the connected product from the drop-down list.
2. Click the **Manage EDID** tab.

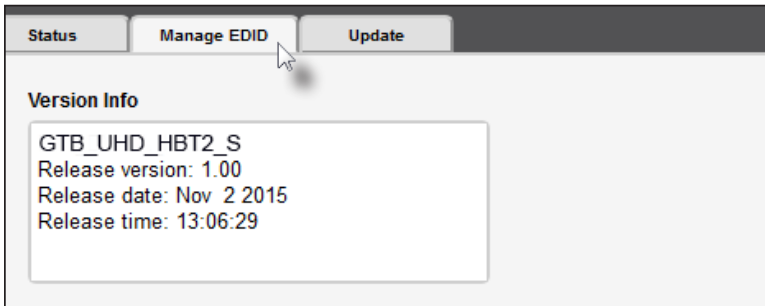

3. Click the **Select EDID From Device / Display** drop-down list to select the desired EDID.

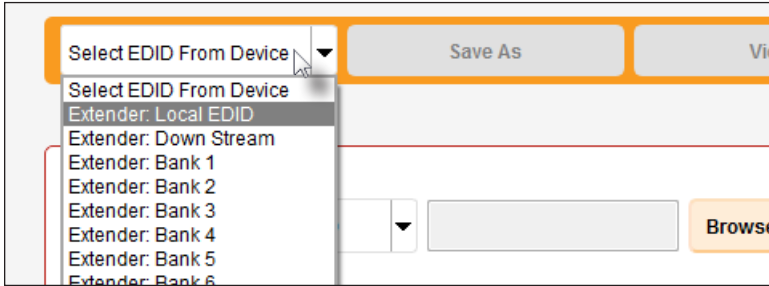

Note that the display, which is connected to the computer, is also available in the drop-down list. In this way, we can download, view, and/or edit the EDID from the display (sink) device.

4. Click the **View** button.



- After a few seconds, Syner-G will also switch to the **EDID Editor** screen. See the Gefen Syner-G™ User Manual for more information on using the EDID Editor.
- Click the desired EDID tab to view specified information on the EDID. Note that some sections within a tab use scroll bars to indicate that more information is available.

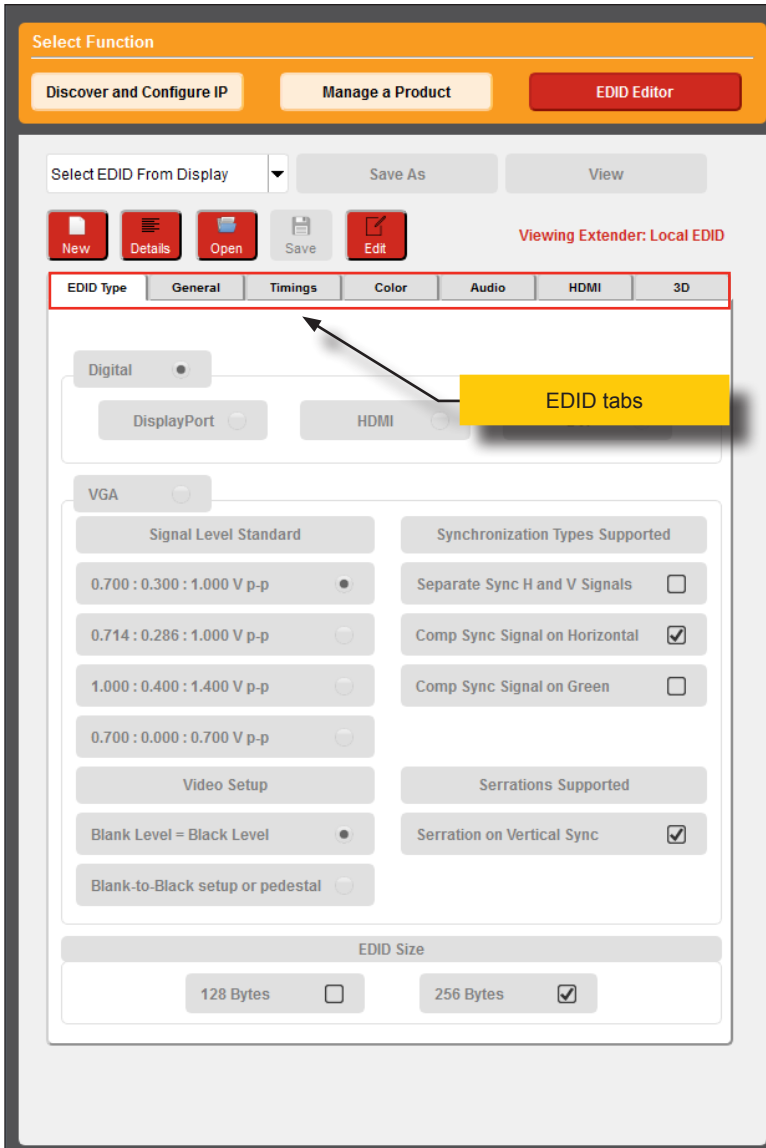

- Click the **Details** button.

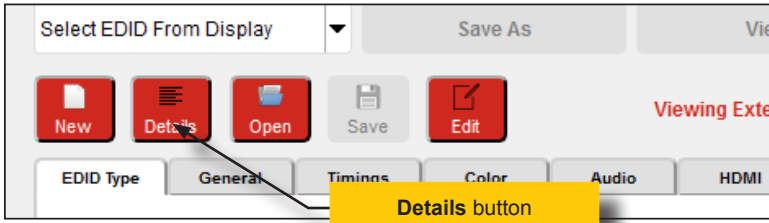

- The **EDID Summary** window will be displayed. Use the horizontal and vertical scroll bar, as needed, to view the EDID information.

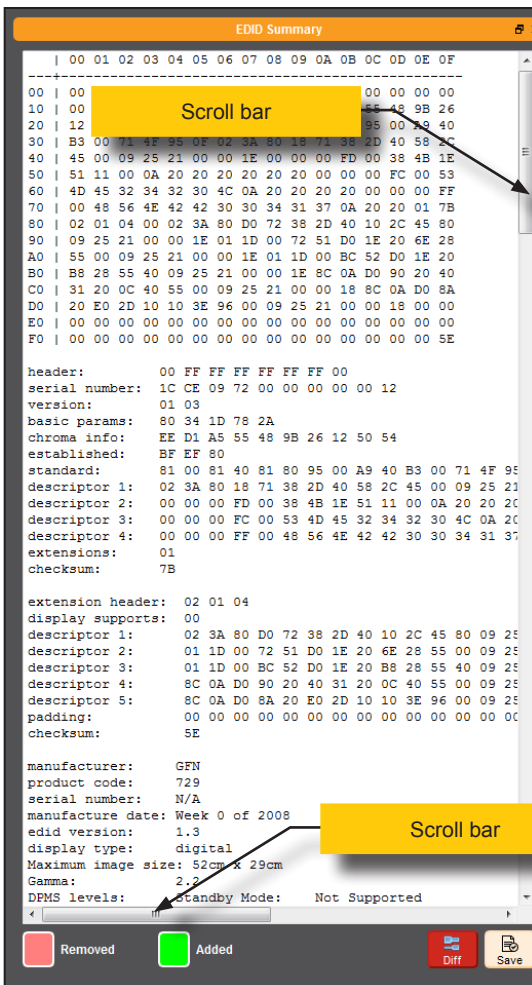

- Click the  button, in the upper-right corner of the **EDID Summary** window to separate the **EDID Summary** window from the main Syner-G window:

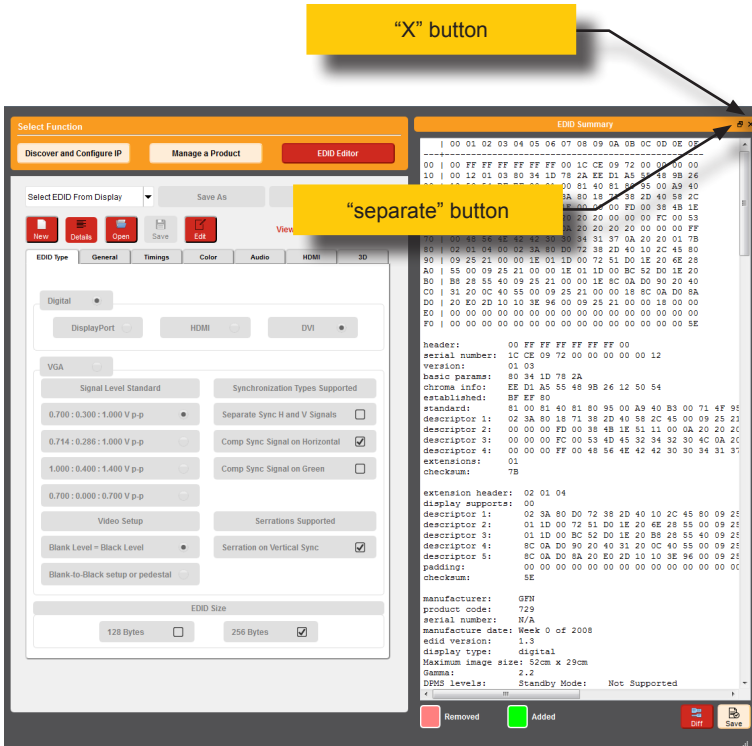

- Double-click the window title bar of the detached EDID Summary window to reattach it to the main window. it to the main Syner-G window.
- To close the **EDID Summary** window, either click the  button, in the upper-right corner of the **EDID Summary** window or click the **Details** button in the main Syner-G window.

This page left intentionally blank.

This page left intentionally blank.

4K ULTRA  **HD**

HDBaseT™ Extender
w/ RS-232, 2-way IR, and POH

4

Appendix

The Syner-G™ Software Suite provides an easy way to perform firmware updates. Before launching Syner-G™, make sure that a USB cable is connected between the product and the computer that is running the Syner-G™ software. Refer to the Syner-G™ Software Suite User Manual for more information on using other features with this product.

1. Launch the Syner-G™ Software Suite from the Start Menu or using the shortcut from the Windows Desktop.



2. Click the **Manage a Product** button.

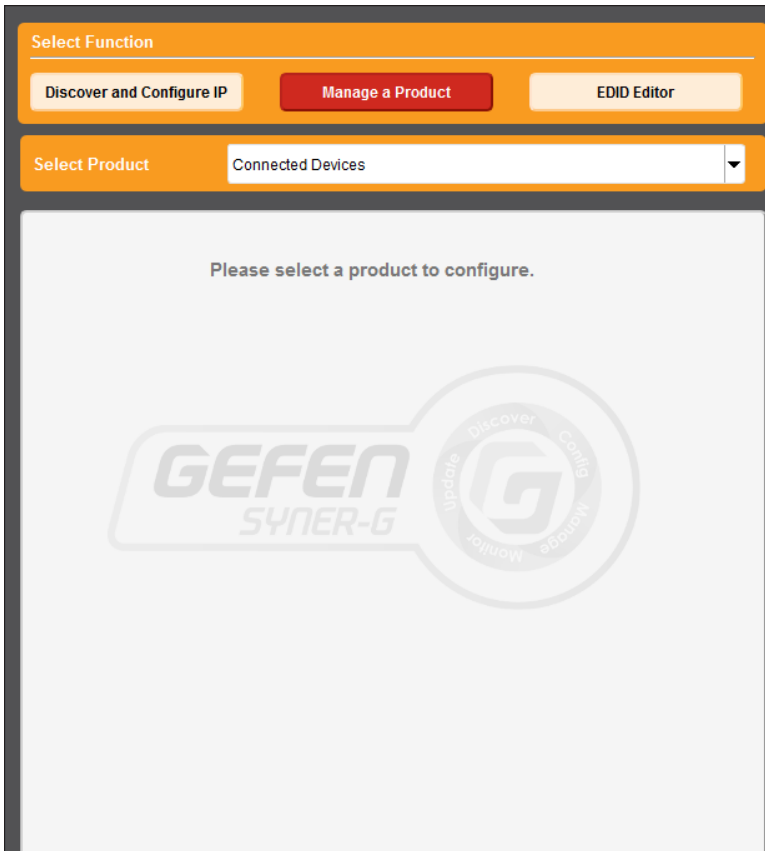

3. Select the product from the **Select your product** drop-down list.

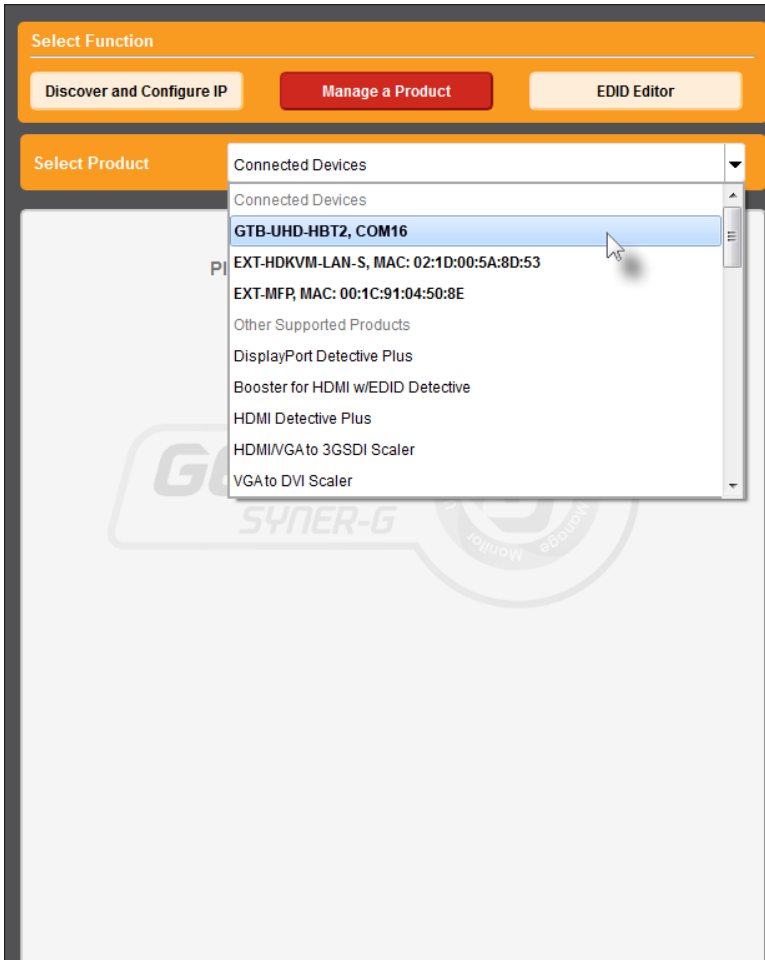

If the product is not detected by Syner-G™, then the product will not be listed in bold type, within the **Select your product** drop-down list. Verify the following:

- ▶ The product is powered and connected to the computer that is running the Syner-G™ Software Suite, using a USB-to-Mini USB cable.
- ▶ Make sure that the USB driver is installed and functioning correctly under Control Panel. See [Verifying the USB Driver \(page 24\)](#) for more information.

4. Click the **Update** tab.

The screenshot shows a web-based interface for managing a device. At the top, there are three main buttons: "Discover and Configure IP", "Manage a Product" (highlighted in red), and "EDID Editor". Below this is a "Select Product" dropdown menu showing "GTB-UHD-HBT2-S, COM16".

The interface has three tabs: "Status", "Manage EDID", and "Update". The "Update" tab is selected, and a mouse cursor is pointing at it. The "Update" section contains several fields and buttons:

- Product:** GTB-UHD-HBT2-S
- Update Method:** USB Serial
- Current Firmware:** 1.00
- Latest Firmware:** 102461
- Check at Startup:** Enabled (red button)
- Last Checked:** Fri Dec 4 17:50:31 2015
- Check for Latest Update:** (yellow button)

Below these fields is a large text area containing the text: "First production firmware."

The "Product Options" section shows "None".

The "Download and Install" section has two options:

- Download Latest Version to Gefen Syner-G:** Includes a progress bar at 0%, a "Start" button, and an "Install" button.
- Download to Computer:** Includes a "Save" button.

The "Install from File" section has a "Select File to Upload" field with a "Browse" button and an "Install" button.

5. Click the **Start** button to begin downloading the firmware.

The screenshot shows the 'Update' tab of the Syner-G™ Software Suite interface. At the top, there are three buttons: 'Discover and Configure IP', 'Manage a Product', and 'EDID Editor'. Below this is a 'Select Product' dropdown menu set to 'GTB-UHD-HBT2-S, COM16'. The main content area has three tabs: 'Status', 'Manage EDID', and 'Update'. Under the 'Update' tab, there are several sections: 1. 'Product: GTB-UHD-HBT2-S' and 'Update Method: USB Serial'. 2. 'Current Firmware: 1.00' and 'Latest Firmware: 102461', with a 'Check at Startup Enabled' button. 3. 'Last Checked: Fri Dec 4 17:50:31 2015' and a 'Check for Latest Update' button. 4. A large empty text box labeled 'First production firmware.'. 5. 'Product Options' set to 'None'. 6. 'Download and Install' section with 'Download Latest Version to Gefen Syner-G' and a progress bar at 0%. A red 'Start' button is highlighted with a mouse cursor, and there are 'Install' and 'Save' buttons. 7. 'Install from File' section with 'Select File to Upload' and a 'Browse' button, and an 'Install' button.

The Syner-G™ Software Suite will automatically download the firmware file for the selected product. This process should take a few seconds.

Once the download process has completed, the progress bar will indicate 100%, as shown on the next page.

A message will also appear at the bottom of the window, indicating that the firmware file was successfully downloaded.

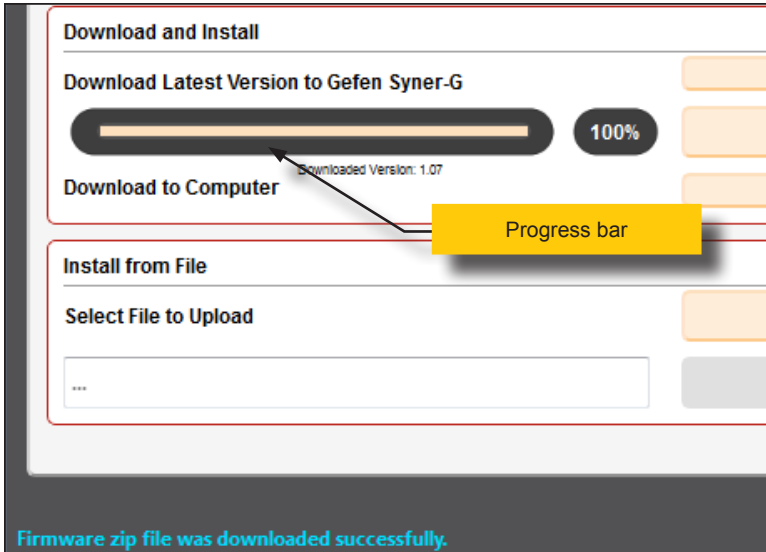

- Click the **Install** button to begin installing the software.

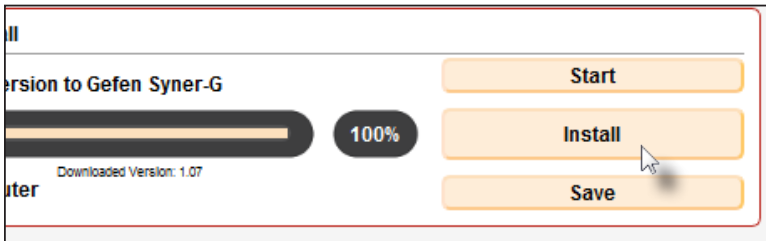

- The installation process will begin and the progress bar will indicate the current status.

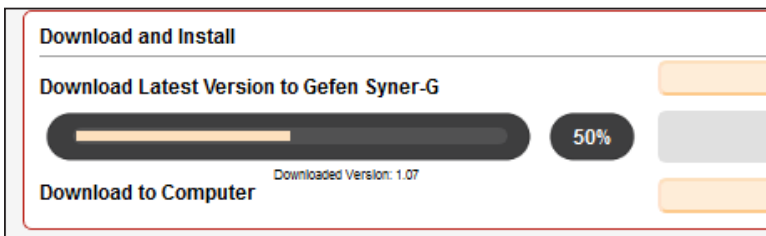

- After the firmware update process has completed, the following message will be displayed.

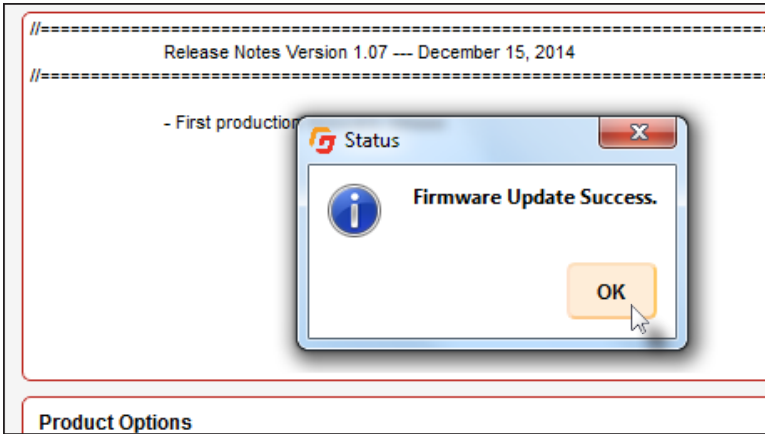

- Click the **OK** button to dismiss the message box.
- The procedure is now complete.

Sender Unit DIP Switches

DIP switch	Function	Default setting (OFF position)
1	EDID mode	Pass-through (downstream) EDID
2	Hot-Plug Detect (HPD)	Always high
3	EDID lock	Disabled
4	HDCP	Pass-through
5	Sender IR carrier	Pass-through
6	Receiver IR carrier	Pass-through
7	IR polarity	Uses Gefen part no. EXT-RMT-EXTIRN
8	Long-Reach mode	HDBT Mode
9	IR carrier frequency	38 kHz
10	IR carrier frequency	Depends on DIP 5 setting
11	N/A	---
12	N/A	---

Receiver Unit DIP Switches

DIP switch	Function	Default setting (OFF position)
1	Sender IR carrier	Pass-through
2	Receiver IR carrier	Pass-through
3	IR polarity	Uses Gefen part no. EXT-RMT-EXTIRN
4	Long-Reach mode	HDBT Mode: Extend 4K up to 330 ft (4:2:0)
5	IR carrier frequency	38 kHz
6	IR carrier frequency	Depends on DIP 1 setting
7	N/A	---
8	N/A	---

Front of RJ-45 Connector

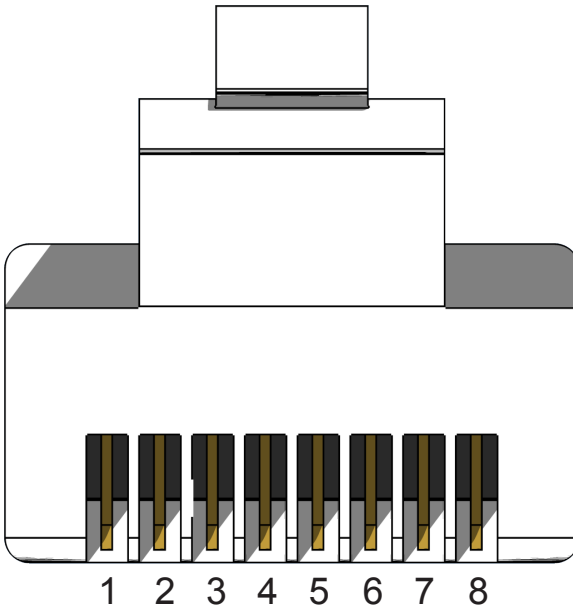

Gefen recommends the TIA/EIA-568-B wiring option. Use the table below when field-terminating cable for use with Gefen products.

Pin	Color	Description
1	Orange / White	TD+ (Transmit Data, positive differential signal)
2	Orange	TD- (Transmit Data, negative differential signal)
3	Green / White	RD+ (Receive Data, positive differential signal)
4	Blue	Unused
5	Blue / White	Unused
6	Green	RD- (Receive Data, negative differential signal)
7	Brown / White	Unused
8	Brown / White	Unused



Information

Shielded CAT-5e (or better) cabling is recommended.

Supported Formats

Resolutions (max.)	<ul style="list-style-type: none"> • 3840 x 2160p 60 Hz (4:2:0) • 4096 x 2160p 30 Hz (4:4:4) • 3840 x 2160p 30 Hz (4:4:4)
--------------------	--

Connectors, Controls, and Indicators

HDMI In (Sender)	• 1 x Type A 19-pin female, locking
HDMI Out (Receiver)	• 1 x Type A 19-pin female, locking
RS-232 (Sender)	• 1 x DB-9, female
RS-232 (Receiver)	• 1 x DB-9, male
Link (Sender / Receiver)	• 1 x RJ-45
IR In / Ext (Sender / Receiver)	• 1 x 3.5mm mini-stereo
IR Out (Sender / Receiver)	• 1 x 3.5mm mini-mono
POH 48V DC (Sender)	• 1 x power connector
Non-POH 48V DC (Receiver)	• 1 x power connector
USB (Sender / Receiver)	• 1 x mini-B type
DIP switches (Sender)	• 12 x piano type, 4 per bank
DIP switches (Receiver)	• 8 x piano type, 4 per bank
Link Indicator (Sender / Receiver)	• 1 x LED, blue
Video Indicator (Sender / Receiver)	• 1 x LED, amber
Power Indicator (Sender / Receiver)	• 1 x LED, green

Operational

Maximum pixel clock	• 300 MHz
Power input	• 48 V DC
Power consumption (Sender / Receiver, combined)	• 11 W
Operating temperature	• +32 to +122 °F (0 to +50 °C)
Operating humidity	• 5% to 90% RH, non-condensing
Storage temperature	• -4 to +185 °F (-20 to +85 °C)
Storage humidity	• 0% to 95% RH, non-condensing
MTBF	• 50000 hours

Physical

Dimensions (W x H x D) (not including connectors)	• 5.8" x 1" x 3.4" (146mm x 25mm x 85mm)
Unit weight	• 0.50 lbs (0.23 kg) each

A

Application Diagram 7

B

Bidirectional IR Control
controlling the display 17
controlling the source 16
from different locations 18

C

Connection Instructions 6

D

Default Settings
receiver unit, DIP 46
sender unit, DIP 46
 DIP Switch Configuration 10
receiver unit 13
sender unit 10

E

EDID
copying 31
downloading 26
hot-plug detect 10
local / pass-through 10
lock 11
uploading 29
viewing 33

F

Features *vi*
 Firmware
updating 40

H

HDCP
control 11

I

IR carrier
notes 14
receiver unit 11
sender unit 11
 IR Carrier Frequency 12, 13, 14
 IR polarity 11, 13

L

LED Status 15
 Long-Reach Mode 11, 14

N

Network Cable Diagram 47

P

Packing List *vii*

R

Receiver Unit 4
 RS-232 Interface 19

S

Sender Unit 2
 Specifications 48
 Syner-G
copying an EDID 31
downloading an EDID 26
uploading an EDID 29
verifying the USB Driver 24
viewing an EDID 33

T

Table of Contents *viii*

U

Updating the Firmware 40
 USB Driver 24



20600 Nordhoff St., Chatsworth CA 91311
1-800-545-6900 818-772-9100 fax: 818-772-9120
www.gefen.com support@gefen.com