

HD Video Wall Controller

EXT-HD-VWC-144

User Manual
Release A2



Important Safety Instructions

GENERAL SAFETY INFORMATION

1. Read these instructions.
2. Keep these instructions.
3. Heed all warnings.
4. Follow all instructions.
5. Do not use this product near water.
6. Clean only with a dry cloth.
7. Do not block any ventilation openings. Install in accordance with the manufacturer's instructions.
8. Do not install or place this product near any heat sources such as radiators, heat registers, stoves, or other apparatus (including amplifiers) that produce heat.
9. Do not defeat the safety purpose of the polarized or grounding-type plug. A polarized plug has two blades with one wider than the other. A grounding type plug has two blades and a third grounding prong. The wide blade or the third prong are provided for your safety. If the provided plug does not fit into your outlet, consult an electrician for replacement of the obsolete outlet.
10. Protect the power cord from being walked on or pinched particularly at plugs, convenience receptacles, and the point where they exit from the apparatus.
11. Only use attachments/accessories specified by the manufacturer.
12. To reduce the risk of electric shock and/or damage to this product, never handle or touch this unit or power cord if your hands are wet or damp. Do not expose this product to rain or moisture.
13. Unplug this apparatus during lightning storms or when unused for long periods of time.
14. Refer all servicing to qualified service personnel. Servicing is required when the apparatus has been damaged in any way, such as power-supply cord or plug is damaged, liquid has been spilled or objects have fallen into the apparatus, the apparatus has been exposed to rain or moisture, does not operate normally, or has been dropped.
15. Batteries that may be included with this product and/or accessories should never be exposed to open flame or excessive heat. Always dispose of used batteries according to the instructions.

Warranty Information

Gefen warrants the equipment it manufactures to be free from defects in material and workmanship.

If equipment fails because of such defects and Gefen is notified within two (2) years from the date of shipment, Gefen will, at its option, repair or replace the equipment, provided that the equipment has not been subjected to mechanical, electrical, or other abuse or modifications. Equipment that fails under conditions other than those covered will be repaired at the current price of parts and labor in effect at the time of repair. Such repairs are warranted for ninety (90) days from the day of reshipment to the Buyer.

This warranty is in lieu of all other warranties expressed or implied, including without limitation, any implied warranty or merchantability or fitness for any particular purpose, all of which are expressly disclaimed.

1. Proof of sale may be required in order to claim warranty.
2. Customers outside the US are responsible for shipping charges to and from Gefen.
3. Copper cables are limited to a 30 day warranty and cables must be in their original condition.

The information in this manual has been carefully checked and is believed to be accurate. However, Gefen assumes no responsibility for any inaccuracies that may be contained in this manual. In no event will Gefen be liable for direct, indirect, special, incidental, or consequential damages resulting from any defect or omission in this manual, even if advised of the possibility of such damages. The technical information contained herein regarding the features and specifications is subject to change without notice.

For the latest warranty coverage information, refer to the Warranty and Return Policy under the Support section of the Gefen Web site at www.gefen.com.

PRODUCT REGISTRATION

Please register your product online by visiting the Register Product page under the Support section of the Gefen Web site.

Contacting Gefen Technical Support

Gefen, LLC
c/o Customer Service
20600 Nordhoff St.
Chatsworth, CA 91311

Telephone: (818) 772-9100
(800) 545-6900

Fax: (818) 772-9120

Email: support@gefen.com

Visit us on the Web: www.gefen.com

Technical Support Hours: 8:00 AM to 5:00 PM Monday - Friday, Pacific Time

HD Video Wall Controller is a trademark of Gefen, LLC.

Important Notice

Gefen, LLC reserves the right to make changes in the hardware, packaging, and any accompanying documentation without prior written notice.

Operating Notes

- The HD Video Wall Controller only operates in 2x2 (two rows of two displays) mode, only. This unit does not support 4x1 (column) or 1x4 (row) configurations.

Features and Packing List

Features

- Create a 2x2 video wall from any Hi-Def source, using four HDTV displays
- Split and scale a single Hi-Def source to four displays
- Input and Output resolutions up to 1080p Full HD and 1920x1200 (WUXGA)
- HDCP compliant
- Advanced Bezel Compensation feature provides compatibility with virtually any screen frame width, and allows for accurate display of the image
- Controllable via front panel, IR, IP (web server interface, Telnet, and UDP), and RS-232
- Easy to use on-screen Graphical User Interface (GUI)
- Advanced web server interface using an external computer
- Handheld IR remote control
- Field-upgradeable firmware via web server interface
- USB port (reserved for future product enhancements)
- Locking power supply connector
- 1U tall rack-mountable enclosure, rack ears included



Packing List

The *HD Video Wall Controller* ships with the items listed below. If any of these items are not present in the box when you first open it, immediately contact your dealer or Gefen.

- 1 x HD Video Wall Controller
- 1 x 6 ft. Locking HDMI Cable (M-M)
- 1 x 6 ft. DB-9 Cable (M-F)
- 1 x IR Extender Module
- 1 x IR Remote Control
- 1 x 12V DC Locking Power Supply
- 1 x Set of Rack Ears
- 1 x Quick-Start Guide

Table of Contents

01 Getting Started

Panel Layout	2
Front	2
Back	3
IR Remote Control Unit	4
Top	4
Bottom	6
Installing the Batteries	7
Setting the IR Channel	8
Installation	9
Connecting the HD Video Wall Controller	9
Sample Wiring Diagram	9

02 Operating the HD Video Wall Controller

Introduction	12
Standby Mode	12
Turning on the HD Video Wall Controller	12
Using IR Control	13
Using the Menu System	14
Accessing the Menu System	14
Setting the Output Resolution	17
Adjusting the Contrast	19
Adjusting the Brightness	21
Adjusting the Saturation	23
Adjusting the Hue	25
Bezel Correction	27
OSD Settings	30
EDID Management	34
Changing the IP Settings	36
Changing the Telnet Settings	39
Changing the UDP Settings	41
System Settings	44

03 Advanced Operation

RS-232 and IP Configuration	48
RS-232 Interface	48
RS-232 Settings	48
IP / UDP Configuration	49
Commands	50
Web Interface	93
Using the built-in Web Interface	93
Video ► I/O Setup	93

EDID ► Assign	98
EDID ► Bank Names	102
EDID ► Upload / Download.....	103
Network.....	105
System	108

04 Appendix

Upgrading the Firmware.....	112
Using the Web Interface.....	112
Using the USB Interface.....	113
Specifications	114

HD Video Wall Controller

01 Getting Started

Panel Layout	2
Front	2
Back	3
IR Remote Control Unit	4
Top	4
Bottom	6
Installing the Batteries	7
Setting the IR Channel	8
Installation	9
Connecting the HD Video Wall Controller	9
Sample Wiring Diagram	9

Panel Layout

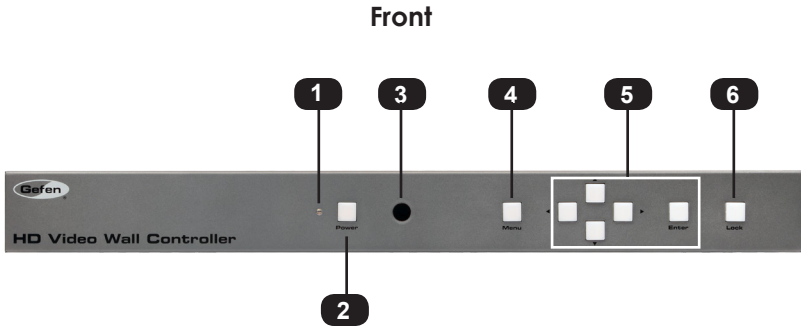

ID	Name	Description
1	Power indicator	This LED glows bright blue when the unit is connected to an AC outlet and the unit is powered on. In standby mode, this LED glows bright red.
2	Power	Press this button to toggle between power-on and standby mode. This button will glow bright blue when the unit is powered on.
3	IR sensor	This IR sensor receives commands from the included IR remote control unit.
4	Menu	Press this button to display the On-Screen Display (OSD) menu system.
5	▲, ◀, ▼, ▶, Enter	These buttons are used to make selections from within the OSD menu system.
6	Lock	Press this button to lock the front panel. This button will glow bright blue when this button is enabled.

Back

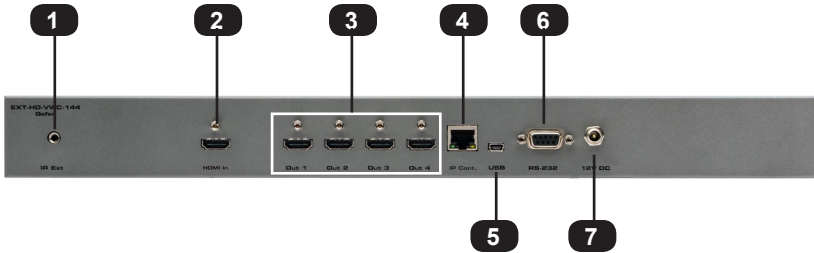

ID	Name	Description
1	IR Ext	Connect the included IR Extender (Gefen part no. EXT-RMT-EXTIRN) to this port.
2	HDMI In	Connect the included HDMI cable between this port and the Hi-Def source.
3	Out (1 - 4)	Connect up to four HDTV displays to these HDMI outputs.
4	IP Control	Connect an Ethernet cable between this jack and a LAN to use IP control. See RS-232 and IP Configuration for more information on setting up IP control.
5	USB	This mini USB port is used for upgrading the firmware. See Upgrading the Firmware for more information.
6	RS-232	Connect the included RS-232 cable from this port to an RS-232 device. See RS-232 and IP Configuration for more information on setting up RS-232.
7	12V DC	Connect the included 12V DC power supply from this power receptacle to an available AC electrical outlet. Do not overtighten the locking connector on the power receptacle.

IR Remote Control Unit

Top

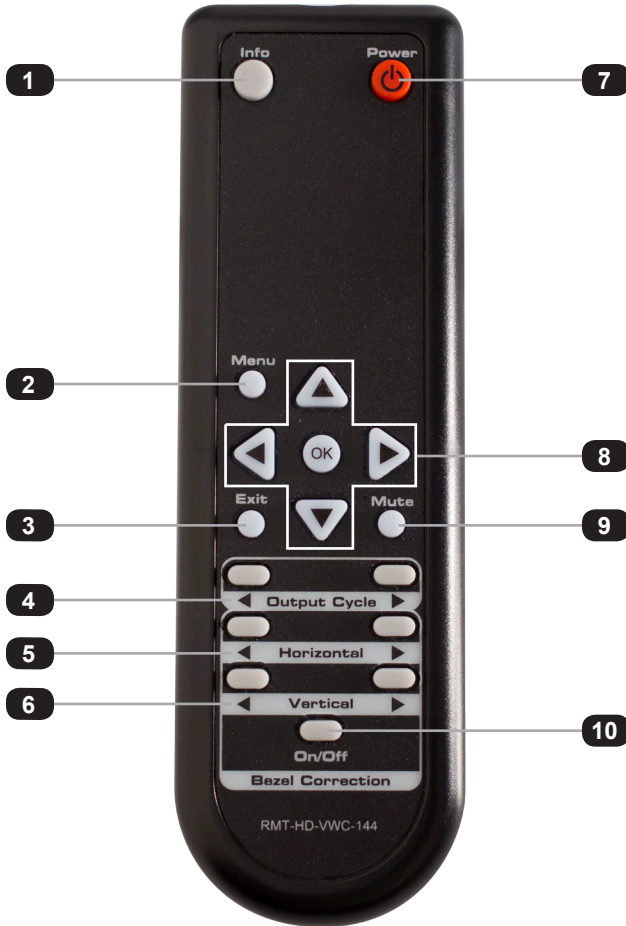

ID	Name	Description
1	Info	Used to toggle notifications on all outputs.
2	Menu	Press this button to display the built-in menu system.
3	Exit	Press this button to exit the main menu or exit from sub-menus.

4	Output Cycle (◀ / ▶)	Press these buttons to cycle through the available output resolutions. For a list of available resolutions, refer to the <code>#set_output</code> command.
5	Horizontal (◀ / ▶)	Press these buttons to adjust the horizontal positioning of the image. Press the ◀ button to move the image to the left. Press the ▶ button to move the image to the right.
6	Vertical (◀ / ▶)	Press these buttons to adjust the vertical positioning of the image. Press the ◀ button to move the image up. Press the ▶ button to move the image down.
7	Power	Press this button to toggle the power state of the HD Video Wall Controller.
8	◀ /▶ /▲ /▼ /OK	Used to access and change features within the menu system. Use the arrow buttons to move around within the menu system or change a value. Press the OK button to make a selection within the menu system.
9	Mute	Mutes the audio on all outputs.
10	Bezel Correction (On / Off)	Used to adjust the bezel correction.

Bottom

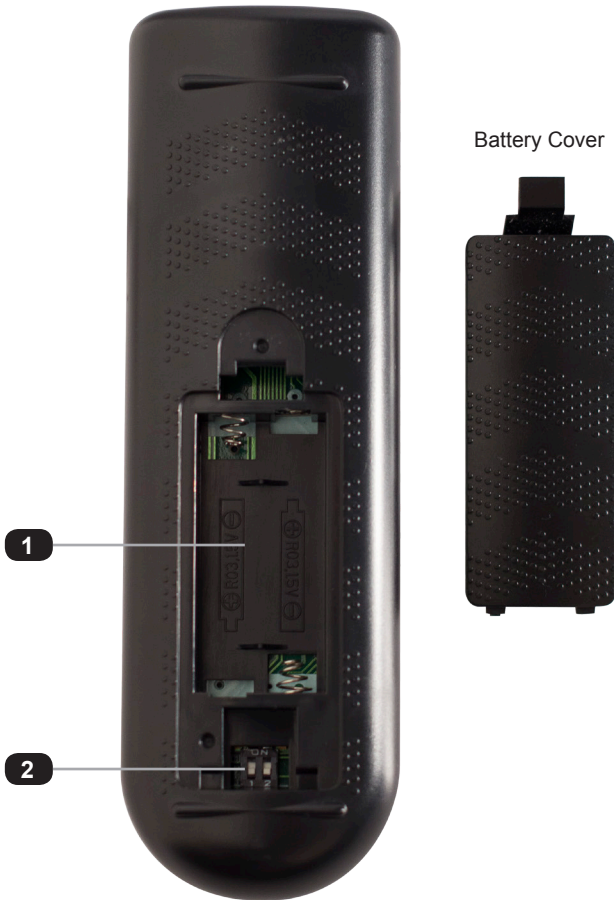

ID	Name	Description
1	Battery slot (shown without batteries)	Holds the batteries for operating the IR remote. Use only 1.5V "AAA"-type batteries. See Installing the Batteries for more information.
2	DIP switch bank	Use these DIP switches to set the IR channel of the remote. See Setting the IR Channel for details.

Installing the Batteries

1. Remove the battery cover on the bottom of the IR remote control unit.
2. Make sure that the batteries are installed with the correct polarity, as shown in the illustration, below. Always use two 1.5V AAA-type batteries.
3. Replace the battery cover.



WARNING: Risk of explosion if battery is replaced by an incorrect type. Dispose of used batteries according to the instructions.

Setting the IR Channel







NOTE: The IR remote must be set to channel 0 in order to communicate with the HD Video Wall Controller.

Make sure that the IR remote is set to channel 0 (see the diagram, below). Otherwise, the HD Video Wall Controller will not work with the IR remote. Future releases of the firmware will allow the IR channel to be changed.



DIP switches

IR Channel	DIP settings
0	<div style="text-align: center;">ON</div>  <div style="display: flex; justify-content: space-around; width: 100%;"> 1 2 </div>
1 (not used)	<div style="text-align: center;">ON</div>  <div style="display: flex; justify-content: space-around; width: 100%;"> 1 2 </div>
2 (not used)	<div style="text-align: center;">ON</div>  <div style="display: flex; justify-content: space-around; width: 100%;"> 1 2 </div>
3 (not used)	<div style="text-align: center;">ON</div>  <div style="display: flex; justify-content: space-around; width: 100%;"> 1 2 </div>

Installation

Connecting the HD Video Wall Controller

1. Use the included HDMI cable to connect the Hi-Def source to the **HDMI In** port on the HD Video Wall Controller.
2. Connect up to four HDTV displays to the **Out** (1 - 4) ports on the HD Video Wall Controller.
3. OPTIONAL: To use IP / UDP / Telnet control, connect an Ethernet cable from the **IP Control** port on the HD Video Wall Controller to a Local Area Network (LAN).
4. OPTIONAL: To extend the range of the IR sensor, connect the included IR extender to the **IR Ext** port on the HD Video Wall Controller.
5. Connect the included 12V DC locking power supply to the power receptacle on the Video Wall Controller. Do not overtighten the locking power connector.
6. Connect the power supply to an available electrical outlet.

Sample Wiring Diagram

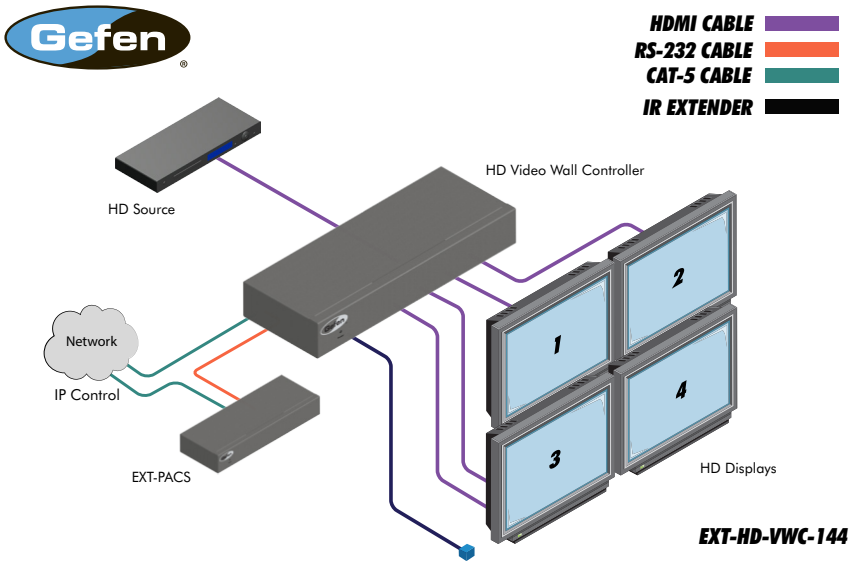

HD Video Wall Controller

02 Operating the HD Video Wall Controller

Introduction.....	12
Standby Mode.....	12
Turning on the HD Video Wall Controller.....	12
Using IR Control.....	13
Using the Menu System.....	14
Accessing the Menu System.....	14
Setting the Output Resolution.....	17
Adjusting the Contrast.....	19
Adjusting the Brightness.....	21
Adjusting the Saturation.....	23
Adjusting the Hue.....	25
Bezel Correction.....	27
OSD Settings.....	30
EDID Management.....	34
Changing the IP Settings.....	36
Changing the Telnet Settings.....	39
Changing the UDP Settings.....	41
System Settings.....	44

Introduction

Standby Mode

The multi-color LED next to the Power button, on the front panel, indicates the power state of the HD Video Wall Controller. In standby mode, power is being supplied to the HD Video Wall Controller but the unit is not turned on. This LED will be red and remain illuminated as long as the unit is in standby mode. If this LED does not illuminate, check the connection between the power receptacle on the HD Video Wall Controller and the AC outlet.

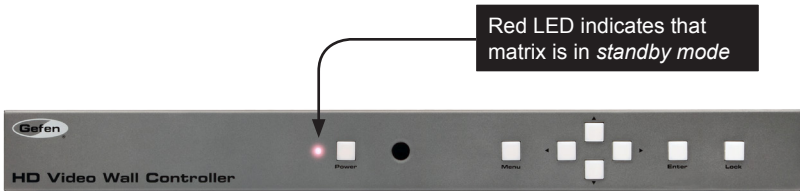

Turning on the HD Video Wall Controller

Once the HD Video Wall Controller is in standby mode, press the Power button to power on the unit. The Power button and the LED indicator will turn blue and both remain illuminated as long as the unit is powered on. To power off the HD Video Wall Controller and return to standby mode, press the Power button again.

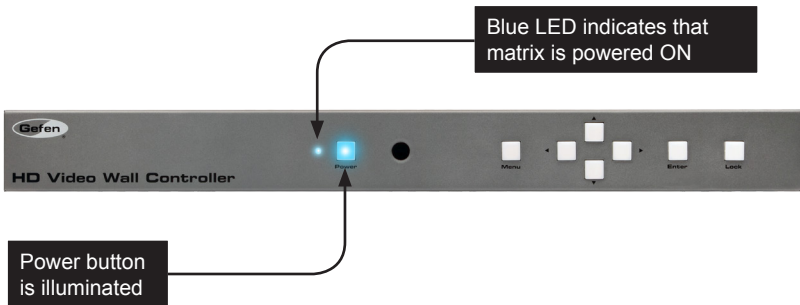

Using IR Control

The HD Video Wall Controller can also be powered-ON or placed in standby mode by using the included IR remote control.

When the HD Video Wall Controller is in *standby mode*, press the **Power** button to power-ON the unit. To power-OFF the unit and place it in *standby mode*, press the **Power** button again. Always make sure to point the IR remote at the IR sensor on the front panel.

The IR remote control also provides full control of all features. See [Accessing the Menu System](#) for more information.

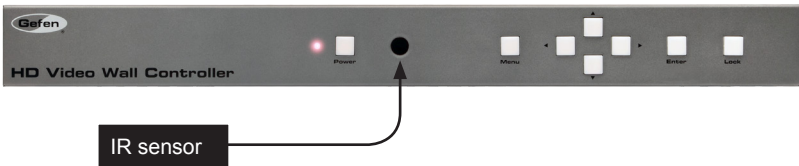

There may be situations where the IR sensor is blocked by a cabinet or other mounting device. In this case, an IR extender (Gefen part no. EXT-RMT-EXTIRN) can be connected to the **IR Ext** port on the back of the HD Video Wall Controller. The sensor on the IR extender behaves exactly like the sensor on the front panel of the matrix. Always point the IR remote control unit in the direction of the IR sensor.

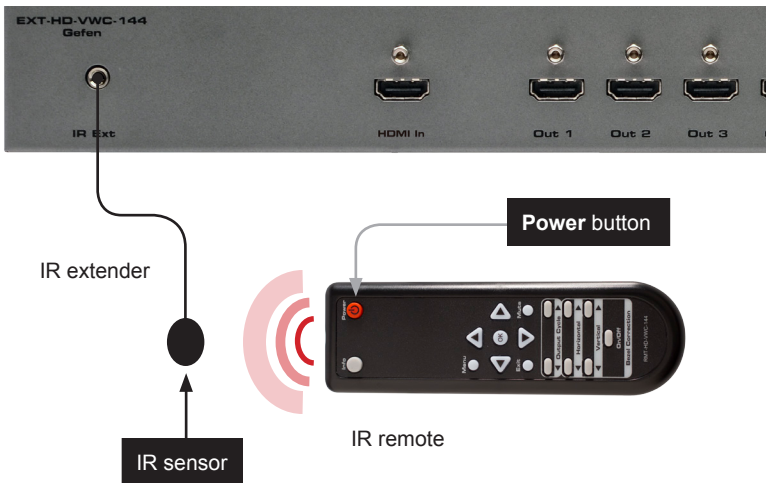

Using the Menu System

Accessing the Menu System

The HD Video Wall Controller uses a built-in menu system to manage and control all video features. To access the menu system, press the **Menu** button on the front panel or on the included IR remote control.

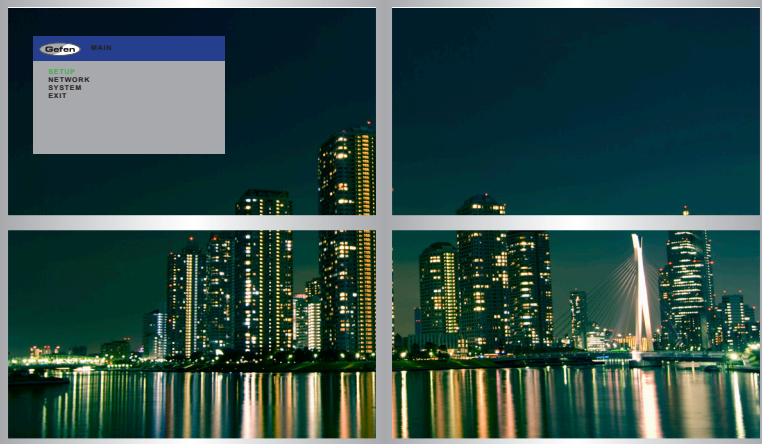

After pressing the **Menu** button on the front panel, the **Menu** button will remain illuminated as long as the menu system is displayed on the screen. By default, the menu system will be displayed within the top-left display.

The time-out value (duration) for the menu system can be changed in the [OSD Settings](#) page of the menu system.

Using the Front Panel Buttons

Use the ◀, ▶, ▲, and ▼ buttons on the front panel to move around within the menu system. Press the ▲ and ▼ buttons to move up and down. Press the ◀ or ▶ buttons to change the value of the current selection. Press the **Enter** button to make the desired selection. The current selection will be highlighted in green.

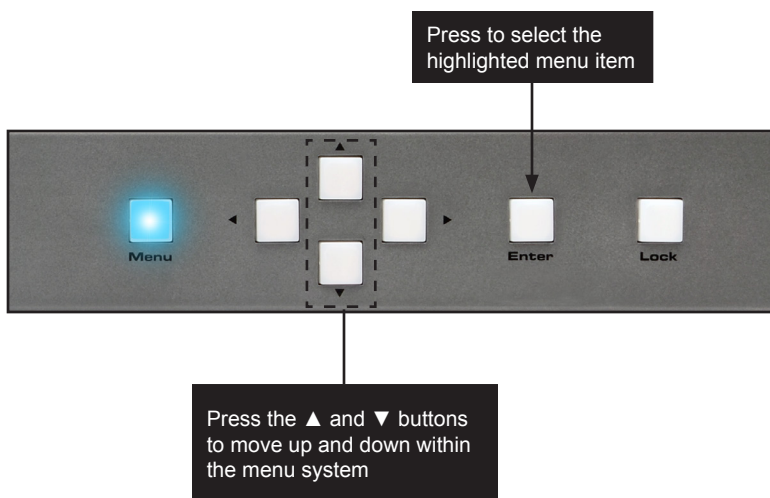
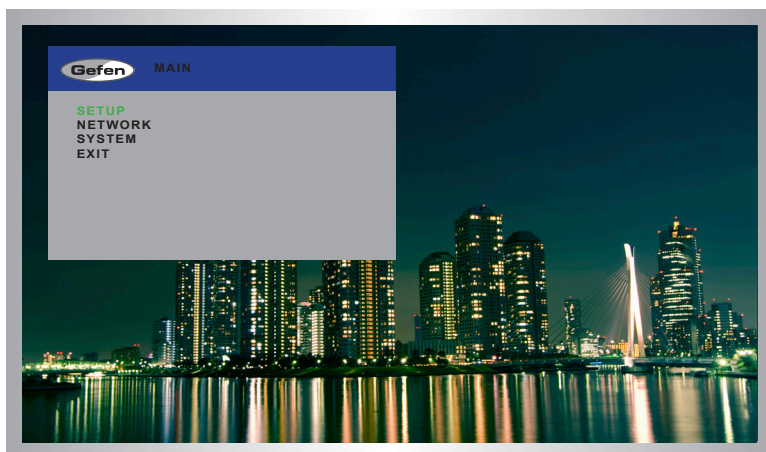

Using the IR Remote Control

The IR remote control has buttons which represent the controls on the front panel. Use the ◀, ▶, ▲, and ▼ buttons to move around within the menu system. Press the ▲ and ▼ buttons to move up and down. Press the ◀ or ▶ buttons to change the value of the current selection. Press the **OK** button to make the desired selection. The current selection will be highlighted in green.

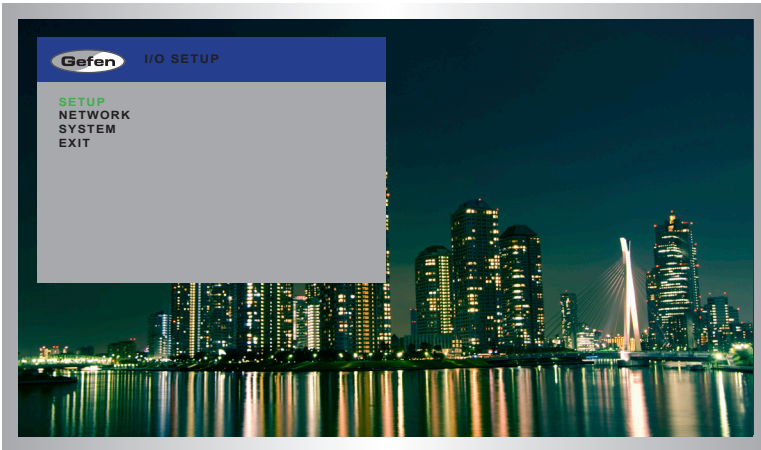

Press to select the highlighted menu item



Press the ▲ and ▼ buttons to move up and down within the menu system

Setting the Output Resolution



NOTE: When changing this setting, make sure that all connected displays can support the selected output resolution.

1. Press the **Menu** button on the front panel or on the IR remote control. The menu system will be displayed.

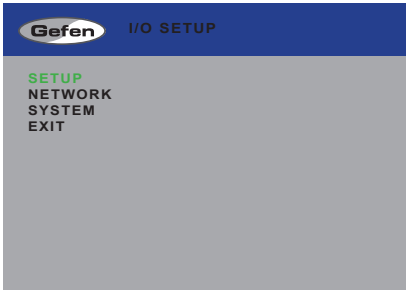

2. Press the **Enter** button. If using the IR remote, press the **OK** button.

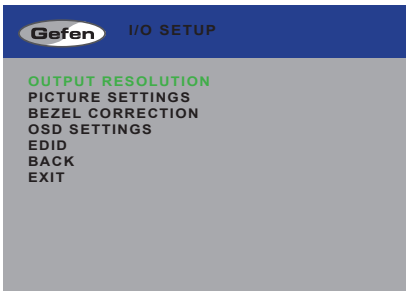

3. Press the **Enter** button again to enter the **Output Resolution** menu. If using the IR remote, press the **OK** button.

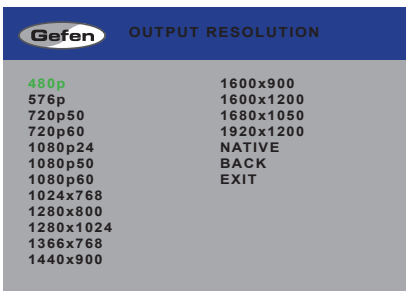

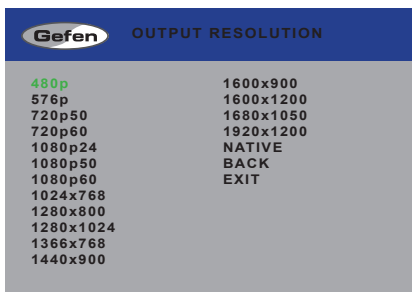

4. Use the ▲ or ▼ buttons to highlight the desired output resolution.
5. Press the **Enter** button to apply the selected resolution. If using the IR remote, press the **OK** button.

Adjusting the Contrast

1. Press the **Menu** button on the front panel or on the IR remote control. The menu system will be displayed.

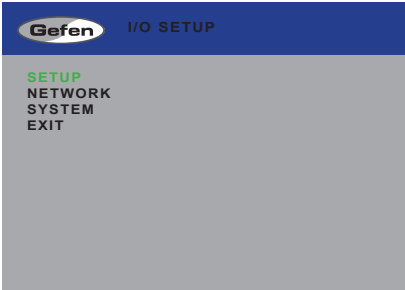

2. Press the **Enter** button. If using the IR remote, press the **OK** button.
3. Use the **▲** or **▼** buttons to select **Picture Settings**.

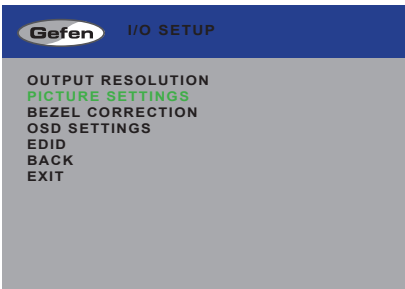

4. Press the **Enter** button. If using the IR remote, press the **OK** button.

The **Contrast** option should already be highlighted in green.

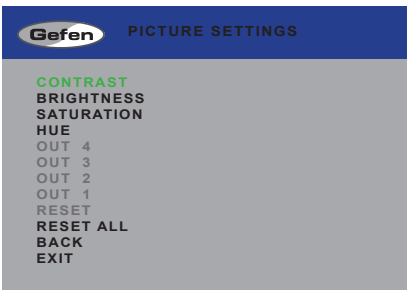

- Press the **Enter** button to select the **Contrast** option. If using the IR remote, press the **OK** button.

The **Contrast** option will be highlighted in orange.

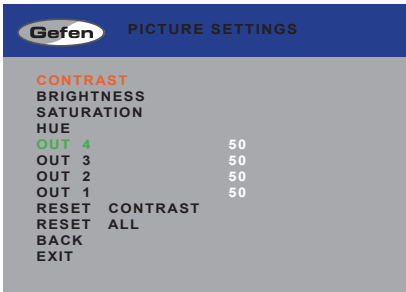

- Use the **▲** or **▼** buttons to highlight the desired output.
- Press the **Enter** button to select the highlighted output. If using the IR remote, press the **OK** button.
- Use the **◀** or **▶** buttons to change the contrast value.

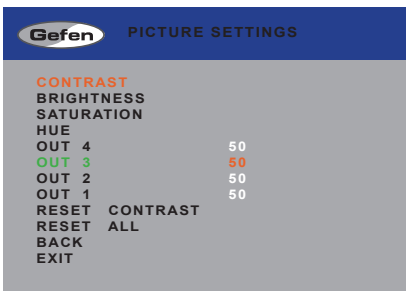

- Press the **Enter** button to accept the current value. If using the IR remote, press the **OK** button.
- To reset the contrast to default values on all outputs, use the **Reset Contrast** option.

Adjusting the Brightness

1. Press the **Menu** button on the front panel or on the IR remote control. The menu system will be displayed.

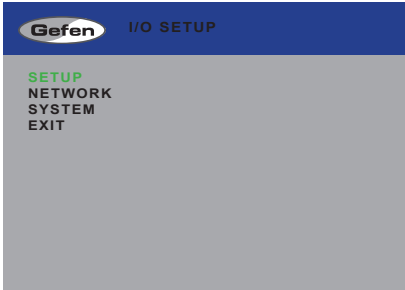

2. Press the **Enter** button. If using the IR remote, press the **OK** button.
3. Use the **▲** or **▼** buttons to select **Picture Settings**.

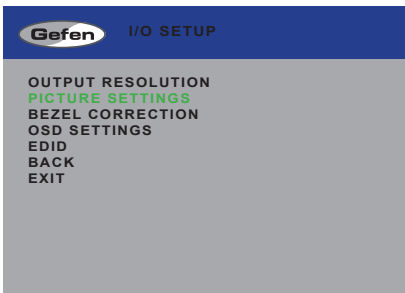

4. Press the **Enter** button. If using the IR remote, press the **OK** button.
5. Use the **▲** or **▼** buttons to highlight **Brightness**.

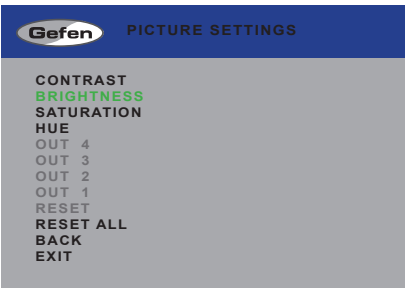

- Press the **Enter** button again to select the **Brightness** option. If using the IR remote, press the **OK** button.

The **Brightness** option will be highlighted in orange.

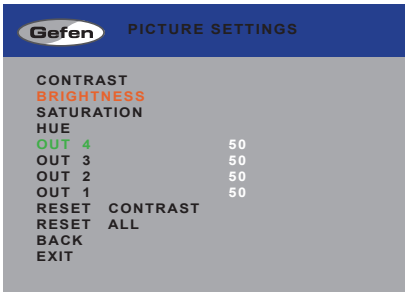

- Use the **▲** or **▼** buttons to highlight the desired output.
- Press the **Enter** button to select the highlighted output. If using the IR remote, press the **OK** button.
- Use the **◀** or **▶** buttons to change the brightness value.

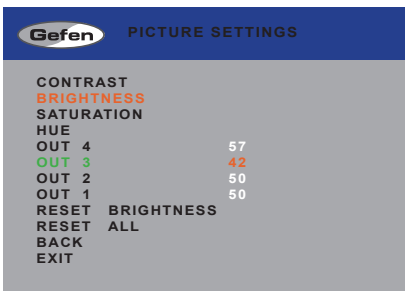

- Press the **Enter** button to accept the current value. If using the IR remote, press the **OK** button.
- To reset the brightness to default values on all outputs, use the **Reset Brightness** option.

Adjusting the Saturation

1. Press the **Menu** button on the front panel or on the IR remote control. The menu system will be displayed.

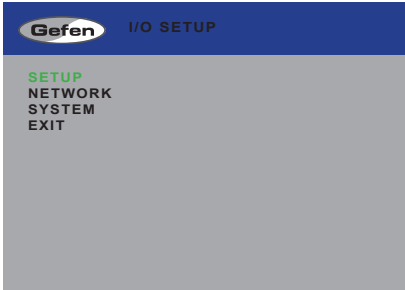

2. Press the **Enter** button. If using the IR remote, press the **OK** button.
3. Use the **▲** or **▼** buttons to highlight **Picture Settings**.

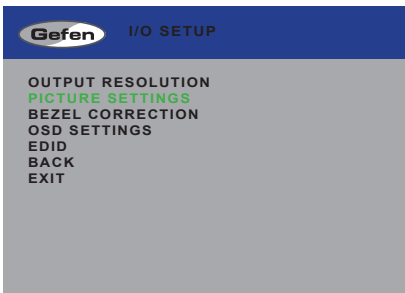

4. Press the **Enter** button. If using the IR remote, press the **OK** button.
5. Use the **▲** or **▼** buttons to highlight **Saturation**.

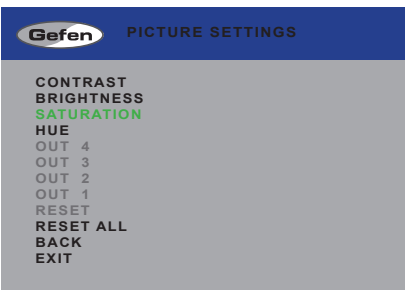

- Press the **Enter** button again to select the **Saturation** option. If using the IR remote, press the **OK** button.

The **Saturation** option will be highlighted in orange.

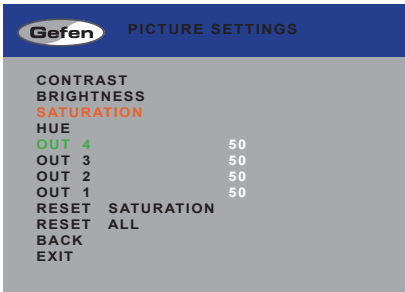

- Use the **▲** or **▼** buttons to highlight the desired output.
- Press the **Enter** button to select the highlighted output. If using the IR remote, press the **OK** button.
- Use the **◀** or **▶** buttons to change the saturation value.

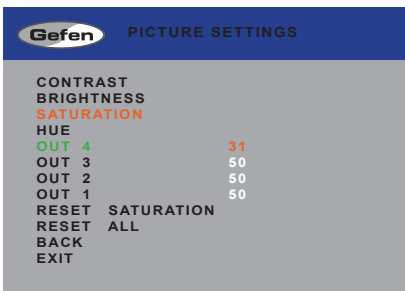

- Press the **Enter** button to accept the current value. If using the IR remote, press the **OK** button.
- To reset the saturation to default values on all outputs, use the **Reset Saturation** option.

Adjusting the Hue

1. Press the **Menu** button on the front panel or on the IR remote control. The menu system will be displayed.



2. Press the **Enter** button. If using the IR remote, press the **OK** button.
3. Use the **▲** or **▼** buttons to highlight **Picture Settings**.

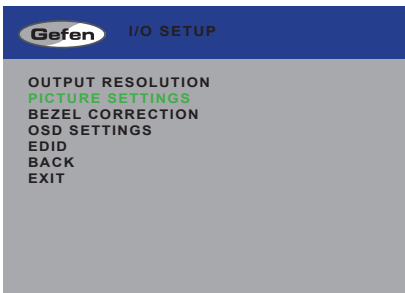

4. Press the **Enter** button. If using the IR remote, press the **OK** button.
5. Use the **▲** or **▼** buttons to highlight **Hue**.

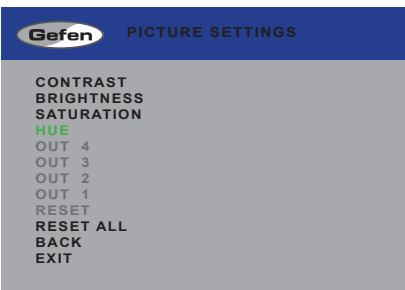

- Press the **Enter** button again to select the **Hue** option. If using the IR remote, press the **OK** button.

The **Hue** option will be highlighted in orange.

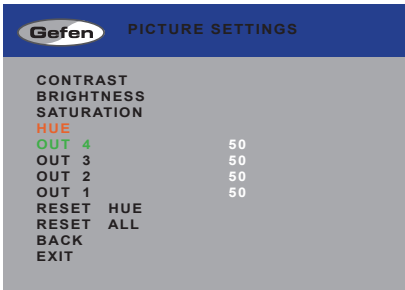

- Use the **▲** or **▼** buttons to highlight the desired output.
- Press the **Enter** button to select the highlighted output. If using the IR remote, press the **OK** button.
- Use the **◀** or **▶** buttons to change the hue value.

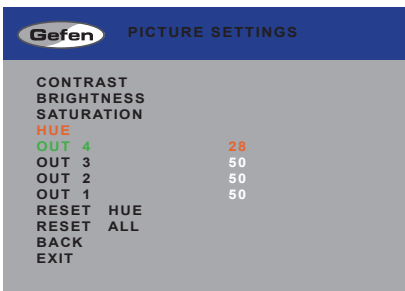

- Press the **Enter** button to accept the current value. If using the IR remote, press the **OK** button.
- To reset the hue to default values on all outputs, use the **Reset Hue** option.

Bezel Correction

Bezel correction is necessary to compensate for the bezel-thickness of each display. Without adjustment, the picture will appear distorted.

1. Press the **Menu** button on the front panel or on the IR remote control. The menu system will be displayed.



2. Press the **Enter** button. If using the IR remote, press the **OK** button.
3. Use the **▲** or **▼** buttons to highlight **Bezel Correction**.

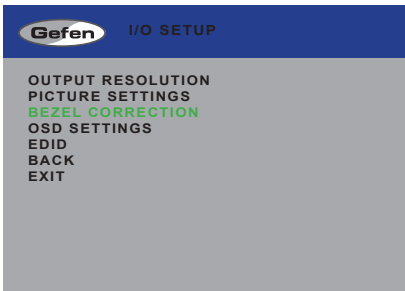

4. Press the **Enter** button. If using the IR remote, press the **OK** button.

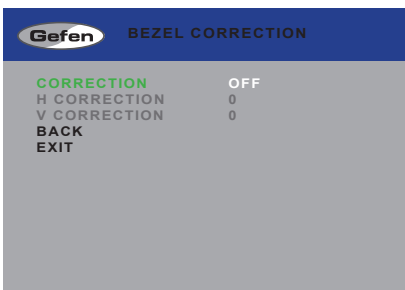

- Press the **Enter** button again to select the **Correction** option. If using the IR remote, press the **OK** button.

The **On / Off** option will be highlighted in orange.

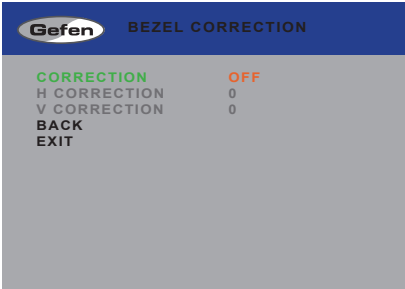

- Use the **◀** or **▶** buttons to enable (**On**) or disable (**Off**) bezel correction.
- Press the **Enter** button to select the desired option. The current state will be highlighted in white and the **H Correction** and **V Correction** options will become available.



- Use the **▲** or **▼** buttons to highlight **H Correction** or **V Correction**.
- Press the **Enter** button to select the desired option. The current value will be highlighted in orange.



11. Use the ◀ or ▶ buttons to change the value.
12. Press the **Enter** button to accept the current value.

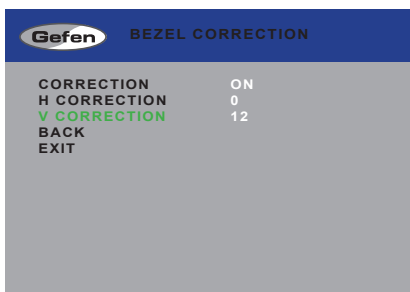

OSD Settings

The OSD Settings menu controls how the OSD is displayed.

1. Press the **Menu** button on the front panel or on the IR remote control. The menu system will be displayed.



2. Press the **Enter** button. If using the IR remote, press the **OK** button.
3. Use the **▲** or **▼** buttons to highlight the option to change. The **Position** option will be highlighted, automatically.

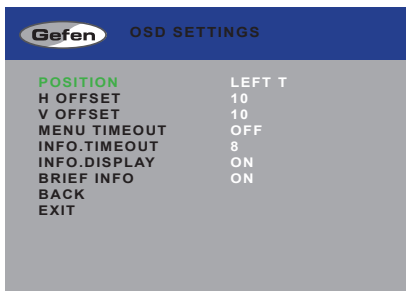

4. Once the desired option is highlighted, press the **Enter** button to select it. If using the IR remote control, press the **OK** button.

When an option is selected, its current value will be highlighted in orange.

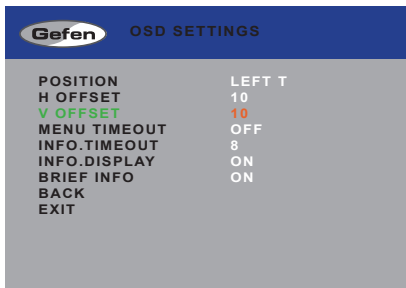

5. Use the ◀ or ▶ buttons to change the current value.
6. Press the **Enter** button to accept the current changes. If using the IR remote control, press the **OK** button.

Position

Assigns the display where the OSD will be displayed, when the Menu button is pressed.

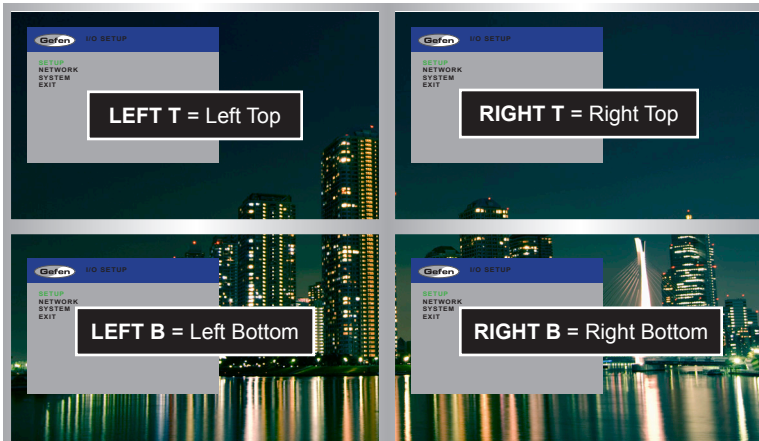

H Offset

The horizontal offset of the OSD, as it appears on the display.



V Offset

The vertical offset of the OSD, as it appears on the display.



Menu Timeout

Once the **Menu** button is pressed, the OSD will appear. Timeout is the duration, in seconds, when the OSD will be automatically dismissed. If set to **Off**, then the OSD must be hidden manually by pressing the **Menu** button.

Info Timeout

By default, each display will show an information (info) window. This window displays the input and output resolution. Menu Timeout is the duration, in seconds, of the OSD before it is automatically hidden.

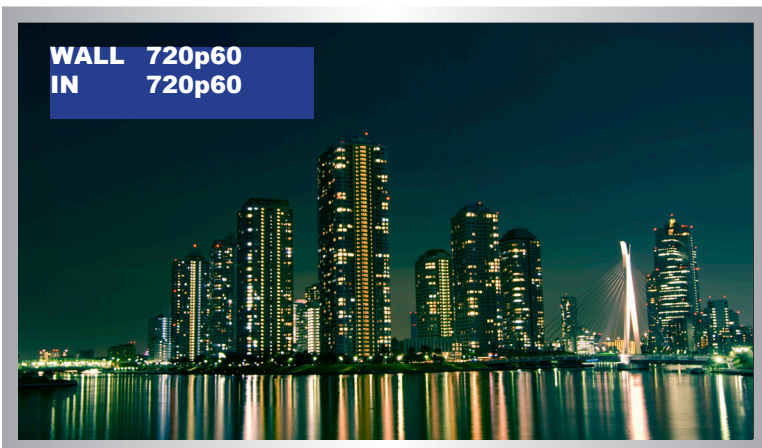

Info Display

Enables (**On**) or disables (**Off**) the Info window. If set to **Off**, the Info window is never displayed.

Brief Info

This option controls what is displayed when **Info Display** set to On. If **Brief Info** is set to **On**, then only the In and Out routing information is displayed. If **Brief Info** is set to **Off**, then the resolution information is also displayed.

EDID Management

1. Press the **Menu** button on the front panel or on the IR remote control. The menu system will be displayed.



2. Press the **Enter** button. If using the IR remote, press the **OK** button.
3. Use the **▲** or **▼** buttons to highlight the **EDID** option.

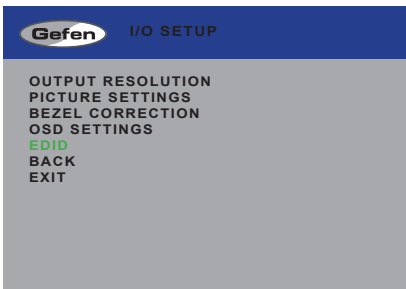

4. Press the **Enter** button to display the EDID menu. If using the IR remote, press the **OK** button.

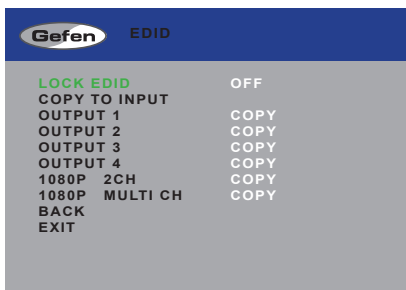

5. Press the **Select** button to select the **Lock EDID** option.
6. Use the ◀ or ▶ buttons to change the value of the **Lock EDID** option.
7. Press the **Select** button to accept the **Lock EDID** value.

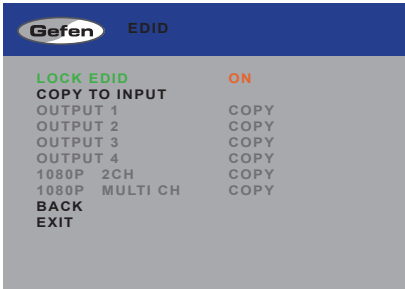

Selecting an EDID

1. Make sure the **Lock EDID** option is set to **Off**.
2. Use the ▲ or ▼ buttons to highlight the desired output, containing the EDID to be copied to the input. The 1080p 2CH or 1080p Multi Ch EDID can also be selected.

When selecting an EDID, make sure that all displays can support the same audio and video capabilities

3. Press the **Enter** button to accept the current output selection. If using the IR remote, press the **OK** button.

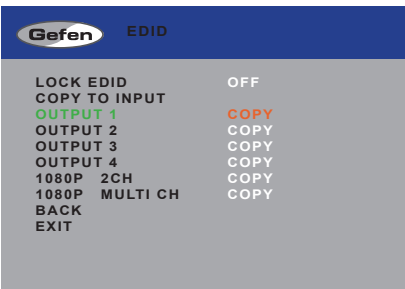

4. The display will flash momentarily. The EDID from the selected output will be copied to the input and will be used by all outputs.

Changing the IP Settings

1. Press the **Menu** button on the front panel or on the IR remote control. The menu system will be displayed.
2. Use the **▲** or **▼** buttons to highlight the **Network** option.

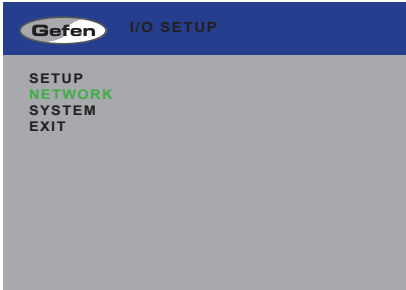

3. Press the **Enter** button to display the **Network** menu. If using the IR remote, press the **OK** button.

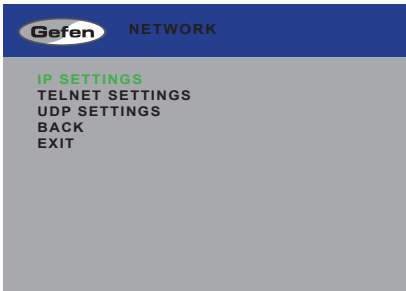

4. Press the **Enter** button again to display the **IP Settings** menu. If using the IR remote, press the **OK** button.

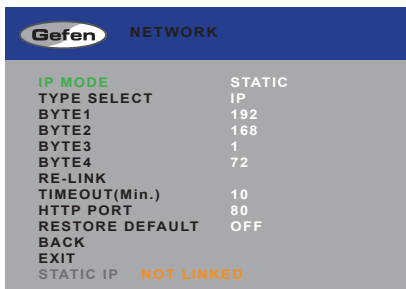

5. Use the ▲ or ▼ buttons to highlight the option to change. The **IP Mode** option will be highlighted, automatically.
6. Once the desired option is highlighted, press the **Enter** button to select it. If using the IR remote control, press the **OK** button.

When an option is selected, its current value will be highlighted in orange.

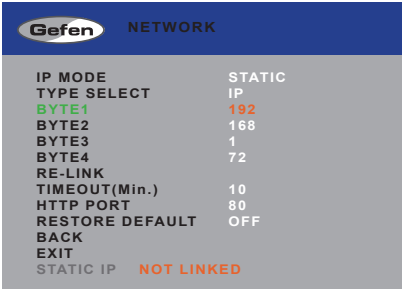

7. Use the ◀ or ▶ buttons to change the current value.
8. Press the **Enter** button to accept the current changes. If using the IR remote control, press the **OK** button.

IP Mode

Set this option to either Static or DHCP. If using the Static option, the IP address must be specified. Use the Byte1, Byte2, Byte3, and Byte4 options to set each of the digits in the IP address, subnet mask, and gateway.

Type Select

Use this option to switch between the IP address (IP), subnet mask (Mask), and gateway (Gate).

Byte

Use the Byte1, Byte2, Byte3, and Byte4 options to set each of the digits in the IP address, subnet mask, and gateway.

Re-link

Use this option to attempt to re-link to the network using the current IP settings.

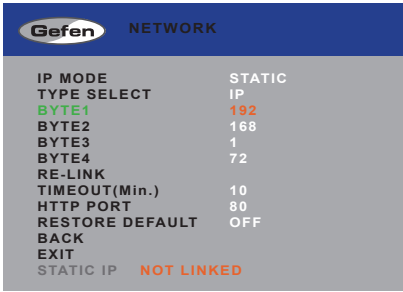

Gefen NETWORK	
IP MODE	STATIC
TYPE SELECT	IP
BYTE1	192
BYTE2	168
BYTE3	1
BYTE4	72
RE-LINK	
TIMEOUT(Min.)	10
HTTP PORT	80
RESTORE DEFAULT	OFF
BACK	
EXIT	
STATIC IP	NOT LINKED

Timeout

Sets the time-out period (in seconds) when using the Re-Link option to link with the network using the current IP settings.

HTTP Port

Sets the HTTP listening port for the HD Video Wall Controller.

Restore Default

This option will reset the default IP settings for the HD Video Wall Controller.

Changing the Telnet Settings

1. Press the **Menu** button on the front panel or on the IR remote control. The menu system will be displayed.
2. Use the **▲** or **▼** buttons to highlight the **Network** option.



3. Press the **Enter** button to display the **Network** menu. If using the IR remote, press the **OK** button.
4. Use the **▲** or **▼** buttons to highlight the **Telnet Settings** option.

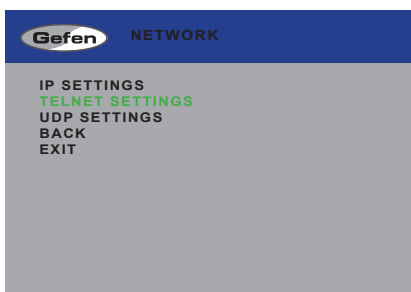

5. Press the **Enter** button again to display the **Telnet Settings** menu. If using the IR remote, press the **OK** button.

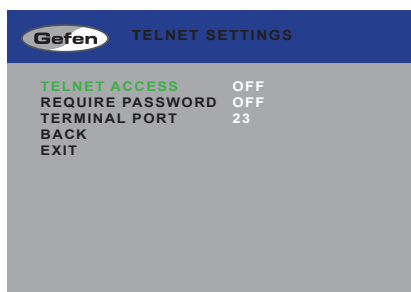

5. Use the ▲ or ▼ buttons to highlight the option to change. The **Telnet Access** option will be highlighted, automatically.
6. Once the desired option is highlighted, press the **Enter** button to select it. If using the IR remote control, press the **OK** button.

When an option is selected, its current value will be highlighted in orange.

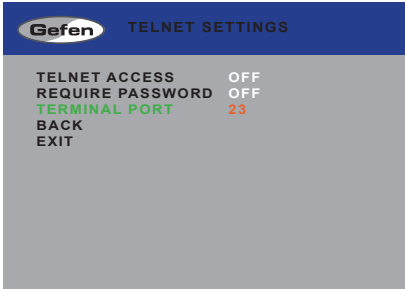

7. Use the ◀ or ▶ buttons to change the current value.
8. Press the **Enter** button to accept the current changes. If using the IR remote control, press the **OK** button.

Telnet Access

Enables (On) or disables (Off) Telnet access for the HD Video Wall Controller.

Require Password

Enables (On) or disables (Off) the password prompt at the beginning of a Telnet session.

Terminal Port

Sets the Telnet listening port for the HD Video Wall Controller.

Changing the UDP Settings

1. Press the **Menu** button on the front panel or on the IR remote control. The menu system will be displayed.
2. Use the **▲** or **▼** buttons to highlight the **Network** option.

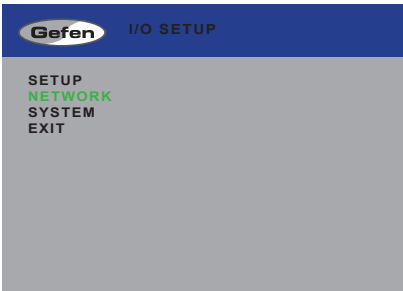

3. Press the **Enter** button to display the **Network** menu. If using the IR remote, press the **OK** button.
4. Use the **▲** or **▼** buttons to highlight the **UDP Settings** option.

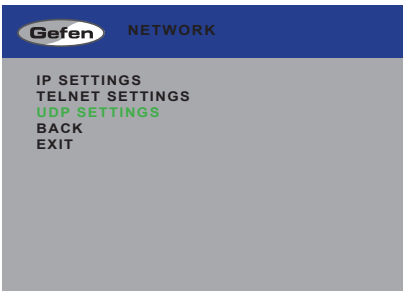

5. Press the **Enter** button again to display the **UDP Settings** menu. If using the IR remote, press the **OK** button.

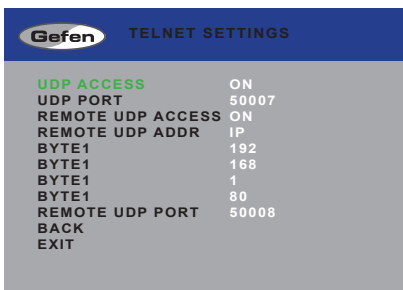

5. Use the ▲ or ▼ buttons to highlight the option to change. The **UDP Access** option will be highlighted, automatically.
6. Once the desired option is highlighted, press the **Enter** button to select it. If using the IR remote control, press the **OK** button.

When an option is selected, its current value will be highlighted in orange.

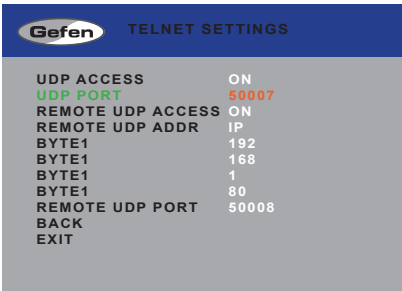

7. Use the ◀ or ▶ buttons to change the current value.
8. Press the **Enter** button to accept the current changes. If using the IR remote control, press the **OK** button.

UDP Access

Enables (On) or disables (Off) UDP access to the HD Video Wall Controller.

UDP Port

Sets the local UDP listening port for the HD Video Wall Controller.

Remote UDP Access

Enables (On) or disables (Off) UDP access on the HD Video Wall Controller.

Remote UDP Addr

Use this option to switch between the UDP IP address (IP), subnet mask (Mask), and gateway (Gate).

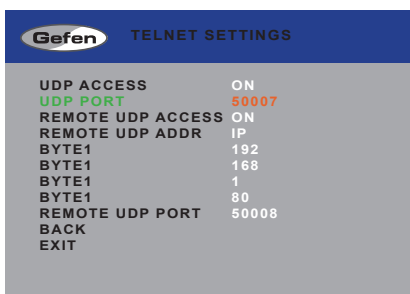

```
Gefen TELNET SETTINGS
UDP ACCESS          ON
UDP PORT           50007
REMOTE UDP ACCESS  ON
REMOTE UDP ADDR    IP
BYTE1              192
BYTE1              168
BYTE1              1
BYTE1              80
REMOTE UDP PORT    50008
BACK
EXIT
```

Byte

Use the Byte1, Byte2, Byte3, and Byte4 options to set each of the digits in the IP address, subnet mask, and gateway.

Remote UDP Port

Sets the remote UDP listening port for the HD Video Wall Controller.

System Settings

1. Press the **Menu** button on the front panel or on the IR remote control. The menu system will be displayed.
2. Use the ▲ or ▼ buttons to highlight the **System** option.



3. Press the **Enter** button to display the **System** menu. If using the IR remote, press the **OK** button.

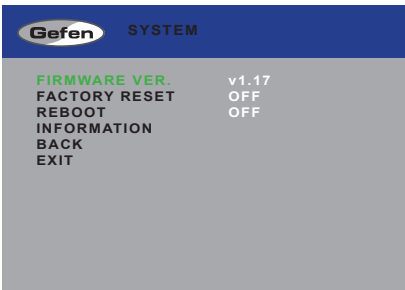

4. Use the ▲ or ▼ buttons to highlight the desired option.

Press the **Enter** button to make the selection. If using the IR remote control, press the **OK** button.

Selecting **Factory Reset** will reset the 4x1 Multiview Seamless Switcher to factory-default settings

Selecting **Reboot** will reboot the 4x1 Multiview Seamless Switcher. This option is the same as disconnecting and reconnecting the AC power cord, on the back of the switcher.

HD Video Wall Controller

03 Advanced Operation

RS-232 and IP Configuration	48
RS-232 Interface	48
RS-232 Settings	48
IP / UDP Configuration	49
Commands	50
Web Interface	93
Using the built-in Web Interface	93
Video ▶ I/O Setup	93
EDID ▶ Assign	98
EDID ▶ Bank Names	102
EDID ▶ Upload / Download	103
Network	105
System	108

RS-232 and IP Configuration

RS-232 Interface

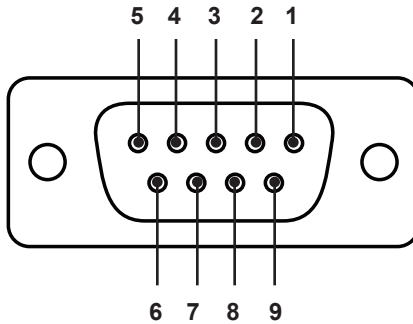

RS-232 Controller

HD Video Wall Controller

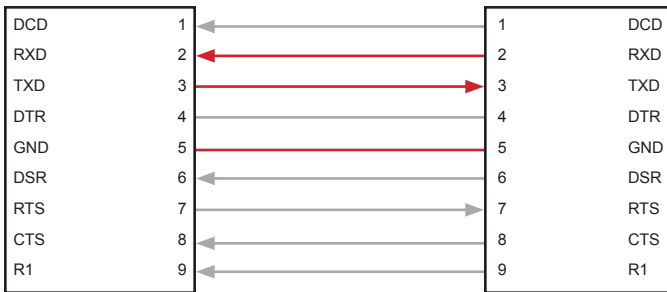

Only TXD, RXD, and GND pins are used.

RS-232 Settings

Description	Setting
Baud rate	19200
Data bits	8
Parity	None
Stop bits	1
Hardware flow control	None



IMPORTANT: When sending Telnet or RS-232 commands, a carriage return (0d) and a line feed (0a) must be included at the end of the command.

IP / UDP Configuration

The HD Video Wall Controller supports IP-based control using Telnet, UDP, or the built-in Web-based GUI. To set up IP control, the network settings for the HD Video Wall Controller must be configured using RS-232. The default network settings for the HD Video Wall Controller are as follows:

Description	IP Address / Port	Description	IP Address / Port
IP Address	192.168.1.72	UDP Port	23
Subnet	255.255.255.0	Remote UDP Port	50008
Gateway	192.168.1.254	Remote UDP IP	192.168.1.255
HTTP Port	80		

1. Connect an RS-232 cable from the PC to the HD Video Wall Controller. Also make sure that an Ethernet cable is connected between the matrix and the network.
2. Launch a terminal emulation program (e.g. HyperTerminal) and use the RS-232 settings listed on the previous page.



NOTE: Depending upon the network, all related IP, Telnet, and UDP settings will need to be assigned. Consult your network administrator to obtain the proper settings.

3. Set the IP address for the matrix using the `#set_ipadd` command.
4. Set the subnet mask using the `#set_netmask` command.
5. Set the gateway (router) IP address using the `#set_gateway` command.
6. Set the Telnet listening port using the `#set_telnet_port` command.
7. Set the HTTP listening port using the `#set_http_port` command.
8. Set the UDP remote IP address for the HD Video Wall Controller using the `#set_udp_remote_ip` command.
9. Set the UDP listening port for the HD Video Wall Controller using the `#set_udp_port` command.
10. Set the UDP remote port for the matrix using the `#set_udp_remote_port` command.
11. Reboot the HD Video Wall Controller to apply all changes, then type the IP address that was specified in step 3, in a Web browser to access the Web GUI. Use the same IP address to Telnet to the HD Video Wall Controller.

Commands

Command	Description
#display_telnet_welcome	Enables or disables the Telnet welcome message
#fadefault	Resets the current routing and masking state to factory-default settings
#help	Displays the list of available commands
#lock_edid	Locks or unlocks the local EDID
#mute	Enables or disables audio muting on the output
#power	Toggles the power on the matrix
#reboot	Reboots the HD Video Wall Controller
#set_bezel	Enables or disables bezel correction
#set_brightness	Sets the brightness for the specified output
#set_contrast	Sets the contrast for the specified output
#set_edid	Assigns the specified EDID to an input or bank
#set_gateway	Sets the IP address of the (router) gateway
#set_hbezel	Sets the horizontal bezel correction value
#set_http_port	Sets the Web server listening port
#set_hue	Set the hue for the specified output
#set_ipadd	Sets the IP address
#set_ipmode	Sets the IP mode
#set_netmask	Sets the subnet mask
#set_output	Sets the output resolution
#set_saturation	Set the saturation for the specified output
#set_telnet_pass	Sets the Telnet password
#set_telnet_port	Sets the Telnet listening port
#set_udp_port	Sets the local UDP port
#set_udp_remote_ip	Sets the remote UDP IP address
#set_udp_remote_port	Sets the remote UDP port
#set_vbezel	Sets the vertical bezel correction value
#show_bezel	Displays the bezel correction state
#show_brightness	Displays the brightness value for the specified output
#show_contrast	Displays the contrast value for the specified output
#show_gateway	Displays the address of the (router) gateway
#show_hbezel	Displays the horizontal bezel value
#show_http_port	Displays the Web server listening port
#show_hue	Displays the hue value for the specified output
#show_ip	Displays the IP address
#show_ipconfig	Displays the current IP configuration

Command	Description
<code>#show_ipmode</code>	Displays the current IP mode (Static or DHCP)
<code>#show_lock_edid</code>	Displays the current EDID lock state
<code>#show_mac_addr</code>	Displays the MAC address
<code>#show_mute</code>	Displays the current audio muting state
<code>#show_netmask</code>	Displays the current net mask
<code>#show_output</code>	Displays the current output resolution
<code>#show_power</code>	Displays the current power state
<code>#show_saturation</code>	Displays the saturation value for the specified output
<code>#show_telnet_port</code>	Displays the Telnet listening port
<code>#show_tcp_access</code>	Displays the current TCP access state
<code>#show_udp_port</code>	Displays the local UDP port
<code>#show_udp_remote_ip</code>	Displays the local UDP port
<code>#show_udp_remote_port</code>	Displays the remote UDP port
<code>#set_vbezel</code>	Displays the vertical bezel value
<code>#show_ver_data</code>	Displays the current hardware and software version
<code>#use_udp_access</code>	Disables or enables UDP access
<code>#use_telnet_pass</code>	Enables or disables the password prompt for Telnet sessions
<code>#use_udp_access</code>	Enables or disables UDP access

#display_telnet_welcome

The #display_telnet_welcome command enables or disables the Telnet welcome message at the start of a Telnet session.

Syntax

```
#display_telnet_welcome param1
```

Parameters

param1 Value [0 ... 1]

Value	Description
0	Disable welcome message
1	Enable welcome message

Example

```
#display_telnet_welcome 1
TELNET WELCOME SCREEN IS ENABLED
```

When enabled and a Telnet session has been started, the following will appear:

```
Welcome to EXT-HD-VWC-144 TELNET
```

#fadefault

The #fadefault command resets the matrix to factory-default settings. Outputs are unmasked and all IP and UDP settings are reset to default settings.

Syntax:

```
#fadefault
```

Parameters:

None

Example:

```
#fadefault
UNIT IS SET TO FACTORY DEFAULTS!!
EXT-HD-VWC-144 v1.17
IP: 192.168.1.72
Netmask: 255.255.255.0
Gateway: 192.168.1.1
```

#help

The #help command displays the list of available RS-232 / Telnet commands. Help on a specific command can be displayed when using `param1`.

Syntax

```
#help param1
```

Parameters

param1 Command name (optional)

Example

```
#help #sipadd  
  
#SIPADD PARAM 1  
SET THE IP ADDRESS  
PARAM 1 = XXX.XXX.XXX.XXX  
WHERE XXX: 0 - 255
```

#lock_edid

The #lock_edid command secures the Local EDID by disabling the automatic loading of the downstream EDID when the matrix is powered.

Syntax

```
#lock_edid param1
```

Parameters

param1 Value [0 ... 1]

Value	Description
0	Disable
1	Enable

Example

```
#lock_edid 0  
EDID IS UNLOCKED
```

```
#lock_edid 1  
EDID IS LOCKED
```

#mute

The #mute command enables or disables audio muting on the outputs.

Syntax

```
#mute param1
```

Parameters

param1

Value

[0 ... 1]

Value	Description
0	Disable
1	Enable

Example

```
#mute 1  
AUDIO IS MUTED
```

```
#mute 0  
AUDIO IS UNMUTED
```

#power

The `#power` command toggles the power state of the HD Video Wall Controller.

Syntax

```
#power param1
```

Parameters

param1 Value [0 ... 1]

Value	Description
0	Off
1	On

Examples

```
#power 0  
POWER IS OFF
```

```
#power 1  
POWER IS ON
```

#reboot

The `#reboot` command reboots the HD Video Wall Controller. Executing this command is the equivalent of disconnecting and reconnecting the AC power cord.

Syntax

```
#reboot
```

Parameters

None

Example

```
#reboot
```

```
---> EXT-HD-VWC-144 v1.8 NET <---
```

#set_bezel

The #set_bezel command enables or disables bezel correction.

Syntax

```
#set_bezel param1
```

Parameters

param1 Value [0 ... 1]

Value	Description
0	Off
1	On

Example

```
#set_bezel 1  
BEZEL CORRECTION MODE IS ON
```

#set_brightness

The #set_brightness command sets the brightness level of the video signal on the specified output. If *param1* = 0, then all outputs are set to the specified brightness level.

Syntax

```
#set_brightness param1 param2
```

Parameters

<i>param1</i>	Output	[0 ... 4]
<i>param2</i>	Level	[0 ... 100]

Examples

```
#set_brightness 1 65  
OUTPUT 1 IS SET TO BRIGHTNESS VALUE 65
```

```
#set_brightness 0 50  
ALL OUTPUTS SET TO BRIGHTNESS VALUE 50
```

#set_contrast

The `#set_contrast` command sets the contrast level of the video signal on the specified output. If *param1* = 0, then all outputs are set to the specified contrast level.

Syntax

```
#set_contrast param1 param2
```

Parameters

<i>param1</i>	Output	[0 ... 4]
<i>param2</i>	Level	[0 ... 100]

Examples

```
#set_contrast 2 74  
OUTPUT 2 IS SET TO CONTRAST VALUE 74
```

```
#set_contrast 0 50  
ALL OUTPUTS SET TO CONTRAST VALUE 50
```

#set_edid

The #set_edid command sets the specified EDID type to an input or bank.

Syntax

```
#set_edid param1 param2 param3 param4
```

Parameters

param1 Source [STRING]

Source	Description
int	Uses default (Internal) EDID
bank	Uses EDID bank
output	Uses EDID on Output (sink)

param2 Source [1 ... 8]

Source	Description
1 ... 4	1 = 720p / 2CH 2 = 720p / Multichannel 3 = 1080p / 2CH 4 = 1080p / Multichannel
1 ... 8	EDID bank
1 ... 4	Output

param3 Target [STRING]

Target	Description
input	Specifies an input
bank	Specifies an EDID bank

param4 Target [1 ... 8]

Value	Description
1	Input
1 ... 8	EDID bank

(continued on next page)

Examples

```
#set_edid int 2 input 4  
INTERNAL EDID 2 IS SAVED TO INPUT4
```

```
#set_edid bank 3 bank 5  
BANK EDID 3 IS SAVED TO BANK5
```

#set_gateway

The `#set_gateway` command sets the gateway address. The gateway must be typed using dot-decimal notation. The HD Video Wall Controller must be rebooted after executing this command. The default gateway is `192.168.1.1`.

Syntax

```
#set_gateway param1
```

Parameters

<i>param1</i>	Gateway
---------------	---------

Example

```
#set_gateway 192.168.1.5  
GATEWAY : 192.168.1.11
```

#set_hbezel

The #set_hbezel command sets the horizontal bezel correction value.

Syntax

```
#set_hbezel param1
```

Parameters

param1 Value [0 ... 254]

Example

```
#set_hbezel 13  
HORIZONTAL BEZEL CORRECTION VALUE IS 13
```

Notes

The maximum horizontal bezel value will depend upon the output resolution. Refer to the table below for more information.

Resolution	H. Bezel (max.)	Resolution	H. Bezel (max.)
480p	60	1280 x 800	200
576i	68	1280 x 1024	248
720p50	220	1366 x 768	213
720p60	220	1440 x 900	232
1080p24	148	1600 x 900	96
1080p50	148	1600 x 1200	254
1080p60	148	1680 x 1050	254
1024 x 768	160	1920 x 1200	80

#set_http_port

The `#set_http_port` command specifies the Web server listening port. The default port setting is 80. The matrix must be rebooted after executing this command. Use the `#show_http_port` command to display the current HTTP listening port.

Syntax

```
#set_http_port param1
```

Parameters

<i>param1</i>	Port	[1 ... 1024]
---------------	------	--------------

Example

```
#set_http_port 82
```

```
HTTP COMMUNICATION PORT 82 IS SET. PLEASE REBOOT THE UNIT.
```

#set_hue

The `#set_hue` command sets the hue for the specified output. If *param1* = 0, then all outputs are set to the specified hue value.

Syntax

```
#set_hue param1
```

Parameters

<i>param1</i>	Value	[0 ... 100]
---------------	-------	-------------

Example

```
#set_hue 1 30  
OUTPUT 1 IS SET TO HUE VALUE 30
```

```
#set_hue 0 45  
ALL OUTPUTS SET TO HUE VALUE 45
```

#set_ipadd

The #set_ipadd command sets the IP address of the HD Video Wall Controller. The IP address must be entered using dot-decimal notation. The HD Video Wall Controller must be rebooted after executing this command. The default IP address is 192.168.1.72. Use the ## command to display the current IP address of the HD Video Wall Controller.

Syntax

```
#set_ipadd param1
```

Parameters

<i>param1</i>	IP address
---------------	------------

Example

```
#set_ipadd 192.168.1.190  
IP ADDRESS : 192.168.1.190
```

#set_ipmode

The #set_ipmode command sets the IP mode to Static or DHCP.

Syntax

```
#set_ipmode param1
```

Parameters

param1 Value [0 ... 1]

Value	Description
0	Static
1	DHCP

Example

```
#set_ipmode 1
```

```
IP MODE SET TO DHCP
```

#set_netmask

The `#set_netmask` command sets the subnet mask. The subnet mask must be entered using dot-decimal notation. The HD Video Wall Controller must be rebooted after executing this command. The default subnet mask is 255.255.255.0. Use the `##` or the `##` command to display the current net mask of the HD Video Wall Controller.

Syntax

```
#set_netmask param1
```

Parameters

<i>param1</i>	Subnet mask
---------------	-------------

Example

```
#set_netmask 255.255.255.0  
NETMASK : 255.255.255.0
```

#set_output

The #set_output command sets the output resolution. The specified output resolution is applied to all outputs.

Syntax

```
#set_output param1
```

Parameters

param1 Value [0 ... 16]

Value	Description
0	480p
1	576p
2	720p @ 50 Hz
3	720p @ 60 Hz
4	1080p @ 24 Hz
5	1080p @ 50 Hz
6	1080p @ 60 Hz
7	1024 x 768
8	1280 x 800
9	1280 x 1024
10	1366 x 768
11	1440 x 900
12	1600 x 900
13	1600 x 1200
14	1680 x 1050
15	1920 x 1200
16	Native

Example

```
#set_output 3
```

```
OUTPUT RESOLUTION IS SET TO 1280x720p 60Hz
```

#set_saturation

The `#set_saturation` command sets the color saturation level for the specified output. If `param1 = 0`, then all outputs are set to the specified color saturation level.

Syntax

```
#set_saturation param1 param2
```

Parameters

<i>param1</i>	Output	[0 ... 4]
<i>param2</i>	Level	[0 ... 100]

Examples

```
#set_saturation 3 65  
OUTPUT 3 IS SET TO SATURATION VALUE 65
```

```
#set_saturation 0 50  
ALL OUTPUTS SET TO SATURATION VALUE 50
```

#set_telnet_pass

The `#set_telnet_pass` command sets the Telnet password. The password cannot exceed 10 characters in length.

Syntax

```
#set_telnet_pass param1
```

Parameters

<i>param1</i>	Password	[STRING]
---------------	----------	----------

Example

```
#set_telnet_pass bossman  
TELNET INTERFACE PASSWORD IS SET
```

#set_telnet_port

The #set_telnet_port command sets the Telnet listening port. The default port setting is 23. The HD Video Wall Controller must be rebooted after executing this command. Use the #show_telnet_port command to display the current Telnet listening port.

Syntax

```
#set_telnet_port param1
```

Parameters

<i>param1</i>	Port	[1 ... 1024]
---------------	------	--------------

Example

```
#set_telnet_port 24
```

```
TELNET COMMUNICATION PORT 24 IS SET. PLEASE REBOOT THE UNIT.
```

#set_udp_port

The `#set_udp_port` command sets the local UDP server listening port. The default port setting is 21. The matrix must be rebooted after executing this command. Use the `#show_udp_port` command to display the current local UDP listening port.

Syntax

```
#set_udp_port param1
```

Parameters

<i>param1</i>	Port	[1 ... 65535]
---------------	------	---------------

Example

```
#set_udp_port 56
UDP COMMUNICATION PORT 56 IS SET.
```

#set_udp_remote_ip

The `#set_udp_remote_ip` command sets the remote UDP IP address. The default UDP remote IP address is 192.168.1.255. The IP address must be specified using dot-decimal notation. The HD Video Wall Controller must be rebooted after executing this command.

Syntax

```
#set_udp_remote_ip param1
```

Parameters

<i>param1</i>	UDP address
---------------	-------------

Example

```
#set_udp_remote_ip 192.168.1.227
REMOTE UDP IP ADDRESS 192.168.1.227 IS SET.
```

#set_udp_remote_port

The `#set_udp_remote_port` command sets the remote UDP listening port. The default remote UDP listening port is 50008. The HD Video Wall Controller must be rebooted after executing this command.

Syntax

```
#set_udp_remote_port param1
```

Parameters

<i>param1</i>	Port	[1 ... 65535]
---------------	------	---------------

Example

```
#set_udp_remote_port 50008
```

```
REMOTE UDP COMMUNICATION PORT 50008 IS SET.
```

#set_vbezel

The #set_vbezel command sets the vertical bezel correction value.

Syntax

```
#set_vbezel param1
```

Parameters

<i>param1</i>	Value	[0 ... 23]
---------------	-------	------------

Example

```
#set_vbezel 10  
VERTICAL BEZEL CORRECTION VALUE IS 10
```

Notes

The maximum vertical bezel value will depend upon the output resolution. Refer to the table below for more information.

Resolution	V. Bezel (max.)	Resolution	V. Bezel (max.)
480p	40	1280 x 800	16
576i	34	1280 x 1024	35
720p50	15	1366 x 768	21
720p60	15	1440 x 900	19
1080p24	31	1600 x 900	93
1080p50	31	1600 x 1200	43
1080p60	31	1680 x 1050	24
1024 x 768	23	1920 x 1200	20

#show_bezel

The #show_bezel command displays the current bezel correction state.

Syntax

```
#show_bezel
```

Parameters

None

Example

```
#show_bezel  
BEZEL CORRECTION MODE IS ON
```

#show_brightness

The #show_brightness command displays the brightness level for the specified output.

Syntax

```
#show_brightness param1
```

Parameters

param1 Output

Example

```
#show_brightness 2  
OUTPUT 2 IS SET TO BRIGHTNESS VALUE 50
```

#show_contrast

The #show_contrast command displays the contrast level for the specified output.

Syntax

```
#show_contrast param1
```

Parameters

<i>param1</i>	Output
---------------	--------

Example

```
#show_contrast 2  
num=2  
OUTPUT 2 IS SET TO CONTRAST VALUE 50
```

#show_gateway

The #show_gateway command displays the current gateway address of the HD Video Wall Controller. Use the #sgateway command to set the gateway address.

Syntax

```
#show_gateway
```

Parameters

None

Example

```
#show_gateway  
GATEWAY ADDRESS IS: 192.168.1.5
```

#show_hbezel

The #show_hbezel command displays the horizontal bezel value. Use the #set_hbezel command to set the horizontal bezel value.

Syntax

```
#show_hbezel
```

Parameters

None

Example

```
#show_hbezel  
HORIZONTAL BEZEL CORRECTION VALUE IS 13
```

#show_http_port

The #show_http_port command displays the current HTTP listening port of the HD Video Wall Controller. Use the #set_http_port command to set the HTTP listening port.

Syntax

```
#show_http_port
```

Parameters

None

Example

```
#show_http_port  
HTTP COMMUNICATION PORT IS: 82
```

#show_hue

The #show_hue command displays the hue for the specified output.

Syntax

```
#show_hue param1
```

Parameters

param1 Output

Example

```
#show_hue 1  
OUTPUT 1 IS SET TO HUE VALUE 45
```

#show_ip

The #show_ip command displays the current IP address of the matrix. Use the #sipadd command to set the IP address.

Syntax

```
#show_ip
```

Parameters

None

Example

```
#show_ip  
IP ADDRESS IS: 192.168.1.239
```

#show_ipconfig

The #show_ipconfig command displays the current TCP/IP settings.

Syntax

```
#show_ipconfig
```

Parameters

None

Example

```
#show_ipconfig
IP CONFIGURATION IS :
IP: 192.168.2.84
NETMASK: 255.255.255.0
GATEWAY: 192.168.2.1
MAC ADDRESS: 00:1c:91:03:b0:19
```

#show_ipmode

The #show_ipmode command displays the current IP mode. To set the IP mode, use the #set_ipmode command.

Syntax

```
#show_ipmode
```

Parameters

None

Example

```
#show_ipmode
IP MODE SET TO DHCP
```

#show_lock_edid

The #show_lock_edid command displays the current EDID lock state. Use the #lock_edid command to lock or unlock the EDID.

Syntax

```
#show_lock_edid
```

Parameters

None

Example

```
#show_lock_edid  
EDID IS UNLOCKED
```

#show_mac_addr

The #show_mac_addr command displays the MAC address of the HD Video Wall Controller.

Syntax

```
#show_mac_addr
```

Parameters

None

Example

```
#show_mac_addr  
MAC ADDRESS IS: 00:1c:91:03:b0:19
```

#show_mute

The #show_mute command displays the current audio muting state. Use the #mute command to enable or disable audio muting.

Syntax

```
#show_mute
```

Parameters

None

Example

```
#show_mute  
AUDIO IS UNMUTE
```

#show_netmask

The #show_netmask command displays the current net mask of the HD Video Wall Controller. Use the #snetmask command to set the net mask.

Syntax

```
#show_netmask
```

Parameters

None

Example

```
#show_netmask  
NETMASK ADDRESS IS: 255.255.255.0
```

#show_output

The #show_output command displays the current output resolution. Use the #set_output command to set the output resolution.

Syntax

```
#show_output
```

Parameters

None

Example

```
#show_output
```

```
OUTPUT RESOLUTION IS SET TO: 1280x720p 60Hz
```

#show_power

The #show_power command displays the current power state. Use the #power command to set the power state (ON or OFF).

Syntax

```
#show_power
```

Parameters

None

Example

```
#show_power  
POWER IS ON
```

#show_saturation

The #show_saturation command displays the saturation for the specified output. Use the #set_saturation command to set the output resolution.

Syntax

```
#show_saturation param1
```

Parameters

<i>param1</i>	Output
---------------	--------

Example

```
#show_saturation 2  
OUTPUT 2 IS SET TO SATURATION VALUE 50
```

#show_telnet_port

The #show_telnet_port command displays the current Telnet port. Use the #set_telnet_port command to set the Telnet port.

Syntax

```
#show_telnet_port
```

Parameters

None

Example

```
#show_telnet_port  
TELNET COMMUNICATION PORT IS: 23
```

#show_tcp_access

The #show_tcp_access command displays the current TCP access state. Use the #use_tcp_access command to enable or disable TCP access.

Syntax

```
#show_saturation param1
```

Parameters

param1 Output

Example

```
#show_saturation 2  
OUTPUT 2 IS SET TO SATURATION VALUE 50
```

#show_udp_port

The #show_udp_port command displays the current remote UDP port. Use the #set_udp_port command to set the remote UDP port.

Syntax

```
#show_udp_port
```

Parameters

None

Example

```
#show_udp_port  
REMOTE_UDP_COMMUNICATION_PORT IS: 56
```

#show_udp_remote_ip

The #show_udp_remote_ip command displays the current remote UDP address. Use the #set_udp_remote_ip command to set the remote UDP address.

Syntax

```
#show_udp_remote_ip
```

Parameters

None

Example

```
#show_udp_remote_ip  
UDP REMOTE ADDRESS IS: 192.168.1.17
```

#show_udp_remote_port

The #show_udp_remote_port command displays the current remote UDP port. Use the #set_udp_remote_port command to set the remote UDP port.

Syntax

```
#show_udp_remote_port
```

Parameters

None

Example

```
#show_udp_remote_port  
REMOTE UDP COMMUNICATION PORT IS: 56
```

#show_vbezel

The #show_vbezel command displays the current vertical bezel correction value. Use the #set_vbezel command to set the vertical bezel correction value.

Syntax

```
#show_vbezel
```

Parameters

None

Example

```
#show_vbezel  
VERTICAL BEZEL CORRECTION VALUE IS 10
```

#show_ver_data

The #show_ver_data command displays the current software and hardware version.

Syntax

```
#show_ver_data
```

Parameters

None

Example

```
#show_ver_data  
SOFTWARE AND HARDWARE VERSION: v1.8
```

#use_tcp_access

The #use_tcp_access command enables or disables TCP access. Use the #show_tcp_access command to display the current TCP access state.

Syntax

```
#sipadd param1
```

Parameters

param1 IP address

Example

```
#sipadd 192.168.2.190
```

```
IP ADDRESS 192.168.2.190 IS SET.
```

#use_telnet_pass

The `#use_telnet_pass` command forces the password credentials for each Telnet session. The default setting is 0 (disabled). Use the `#set_telnet_pass` command to set the Telnet password.

Syntax

```
#use_telnet_pass param1
```

Parameters

param1 Value [0 ... 1]

Value	Description
0	Disable password
1	Enable password

Examples

```
#use_telnet_pass 1  
TELNET INTERACE PASSWORD IS ENABLED
```

```
#use_telnet_pass 0  
TELNET INTERACE PASSWORD IS DISABLED
```

#use_udp_access

The #use_udp_access command enables or disables UDP access mode.

Syntax:

```
#use_udp_access param1
```

Parameters:

param1 Value [0 ... 1]

Value	Description
0	Disable UDP
1	Enable UDP

Example:

```
#use_udp_access 1
```

```
UDP ACCESS IS ENABLE
```

Web Interface

Using the built-in Web Interface

Access the built-in Web interface by entering the IP address of the HD Video Wall Controller that was specified in step 3 under [IP / UDP Configuration](#).

The Web interface is divided into four pages: **Video**, **EDID**, **Network**, and **System**. Each page is represented by a tab at the top-most portion of the screen. Some of the pages (**Video**, **EDID**, and **Network**) have a set of sub-tabs which provide additional functionality. Click on the desired tab / sub-tab to open the desired page.

Video ► I/O Setup

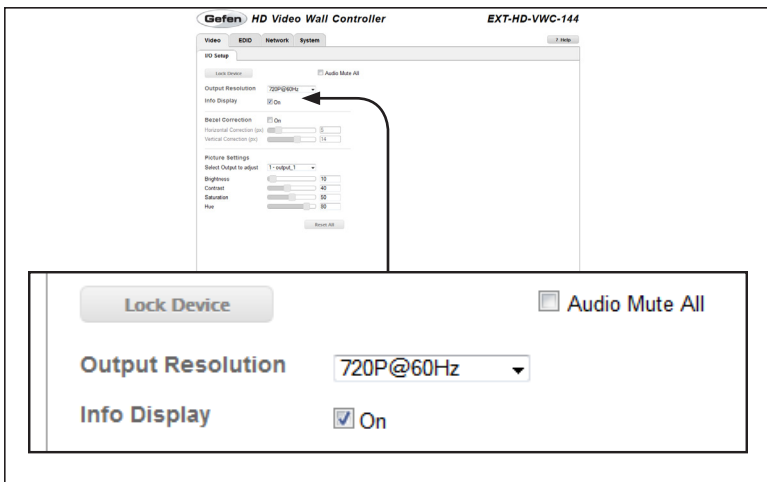

Lock Device

This feature will be available in a future release of the software.

Audio Mute All

Click this check box to enable audio muting on all outputs. When enabled, the message "Audio is muted" will be displayed. Click the check box again to disable audio muting. The factory-default setting is *disabled*.

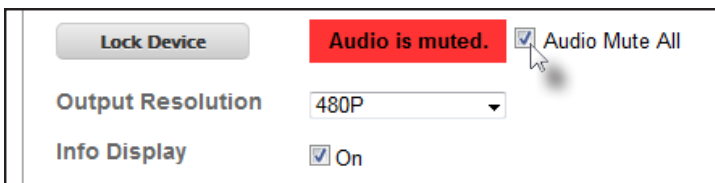

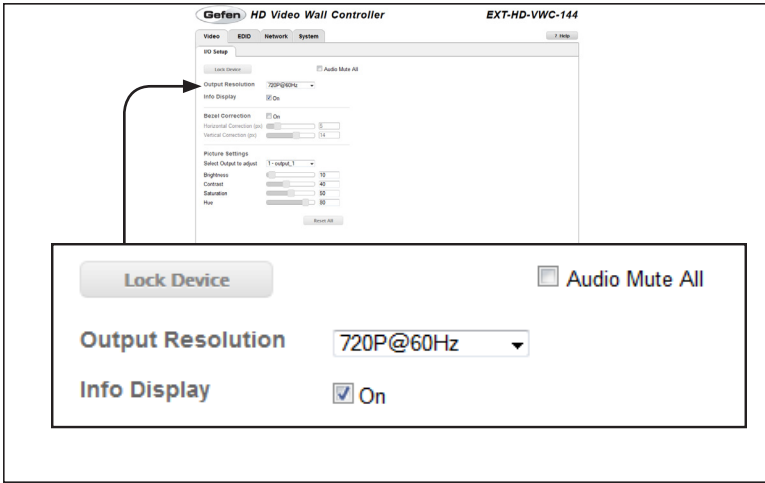

Output Resolution

Select the desired output resolution from the drop-down list. The following output resolutions are available:

Options	
480p	1280 x 1024
576p	1366 x 768
720p @ 50 Hz	1440 x 900
720p @ 60 Hz	1600 x 900
1080p @ 24 Hz	1600 x 1200
1080p @ 50 Hz	1680 x 1050
1080p @ 60 Hz	1920 x 1200
1024 x 768	Native (Output 1)
1280 x 800	

Help

Click the button to receive context-sensitive help for the features on the selected page.

Context-sensitive help for the **Video > I/O Setup** page:

The image shows a screenshot of the Gefen HD Video Wall Controller web interface. The main window displays the "I/O Setup" page, which includes sections for "Output Resolution", "Lock Device", "Audio Mute All", "Info Display", "Bezel Correction", and "Picture Settings". A context-sensitive help window titled "I/O Setup Help" is open, providing detailed information for each section. A separate "Help" button is shown, which is linked to the help window. The main interface also features a "Lock Device" button, an "Audio Mute All" checkbox, and a dropdown menu for "Output Resolution" set to "720P@60Hz". The "Info Display" checkbox is checked, and a mouse cursor is hovering over it.

I/O Setup Help

Output Resolution
Standard output resolutions are provided. Select a resolution from the dropdown list that all outputs will be scaled to.

Lock Device
Enable this option to prevent unwanted changes to the device.

Audio Mute All
Enable/Disable audio on all outputs.

Info Display
Enable/Disable the info notifications that appear on the outputs.

Bezel Correction

Not Corrected Corrected

Bezel Correction is necessary to compensate for the bezel thickness on displays. Without adjusting these options the output picture will appear distorted. Adjust the horizontal and vertical amounts until the image no longer appears irregular.

Picture Settings
Each output's picture settings can be individually adjusted. Select the display output from the drop-down list. Adjustments are live. This is an important step to correct picture differences between displays.

Gefen HD Video Wall Controller EXT-HD-VWC-144

Video EDID Network System

I/O Setup

Lock Device Audio Mute All

Output Resolution: 720P@60Hz

Info Display: On

Bezel Correction: On

Horizontal Correction (px): 0

Vertical Correction (px): 0

Picture Settings

Select Output to adjust: Output 1

Brightness: 50

Contrast: 40

Saturation: 50

Hue: 0

Save All

Lock Device Audio Mute All

Output Resolution: 720P@60Hz

Info Display: On

Info Display

Place a check mark in this check box to enable notifications to the outputs. Click this check box to remove the check mark and disable notifications. The factory-default setting is *enabled*.

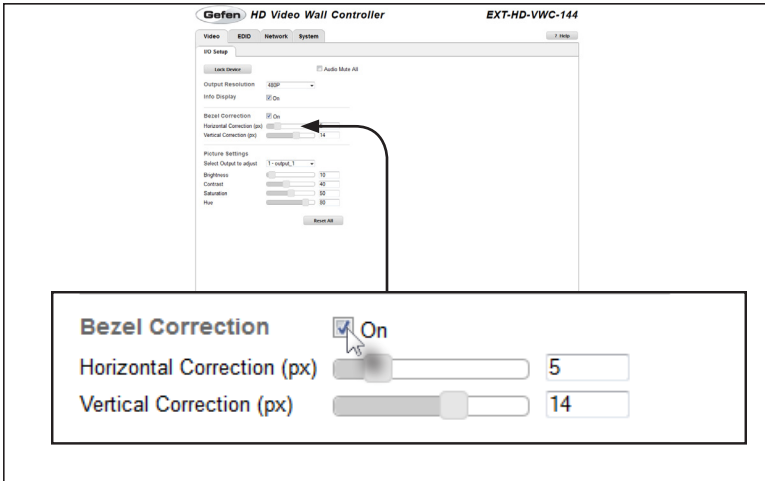

Bezel Correction

Place a check mark in this check box to enable bezel correction. When enabled, the HD Video Wall Controller will use the specified horizontal and vertical values. By default, Bezel Correction is *disabled*.

Options	Range
Horizontal Correction	0 . . . 23
Vertical Correction	0 . . . 23

Bezel correction is necessary to compensate for the bezel-thickness of each display. Without adjustment, the picture will appear distorted.

The example, below, is using bezel correction to ensure that each portion of the image is properly and evenly distributed between the four displays.



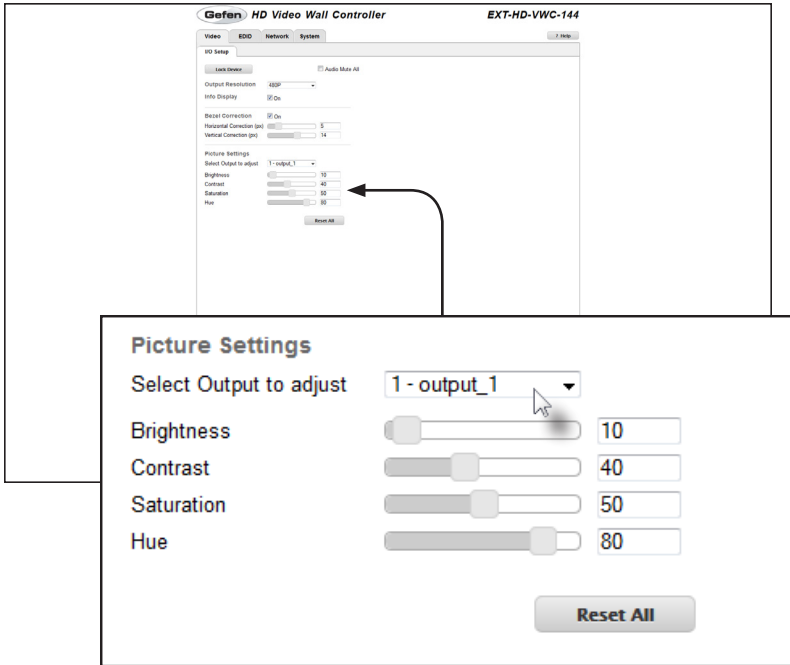

Select Output to adjust

Select the desired output, to adjust, from the drop-down list.

Brightness, Contrast, Saturation, and Hue can be independently adjusted for each of the four outputs.

Picture Settings	Range
Brightness	0 ... 100
Contrast	0 ... 100
Saturation	0 ... 100
Hue	0 ... 100

Reset All

Click this button to reset all I/O settings to their factory-default settings.

EDID ► Assign

The screenshot shows the 'Gefen HD Video Wall Controller' web interface for model 'EXT-HD-VWC-144'. The 'EDID' tab is active, showing an 'Assign' section with a 'Lock EDID' button. Below this, the 'Copy EDID From' dropdown is set to 'Bank 1'. The 'Copy EDID To - Please select from the inputs below' section contains a table of inputs:

Copy To	EDID Modes	Input #	Name
<input type="checkbox"/>	Internal - 720p 2 ch audio	1	Input 1

A callout box highlights the 'Lock EDID' button and the 'Copy EDID From' dropdown.

Lock EDID

This feature will be available in a future release of the software.

Copy EDID From

Select the EDID from the drop-down list. The selected EDID will be copied to the EDID specified under the Inputs or Banks section.

Options
720p 2 ch audio
720p Multi ch
1080p 2 ch audio
1080p Multi ch
Bank 1 ... Bank 8
Output_1 ... Output_4

Gefen® HD Video Wall Controller EXT-HD-VWC-144

Video EDID Network System

Copy EDID From: Bank 1

Copy EDID To: Please select from the inputs below

Inputs

Copy To	EDID Modes	Input #	Name	EDID Source	EDID Name
<input type="checkbox"/>	Internal - 720p 2 ch audio	1	Input 1	Bank 1	GEFEN_VPT_RL

Lock EDID

Copy EDID From: Bank 1

Copy EDID To - Please select from the inputs below

Inputs

Copy To	EDID Modes	Input #	Name
<input type="checkbox"/>	Internal - 720p 2 ch audio	1	Input 1

Copy EDID To (Inputs)

Place a check mark in this check box to copy the EDID from the “Copy EDID From” drop-down list to the input.

Options
Internal - 720p 2 ch audio
Internal - 720p Multi ch
Internal - 1080p 2 ch audio
Internal - 1080p Multi ch
External - Output
Custom - User

Gefen® HD Video Wall Controller EXT-HD-VWC-144

Video EDID Network System

Copy EDID From: Bank 1

Copy EDID To: Please select from the inputs below

Inputs

Copy To	EDID Model	Input #	Name	EDID Source	EDID Name
<input type="checkbox"/>	Viewed: "000 2 in audio"	1	Input 1	Bank 1	GEFEN_VPT_S1

Banks

Copy To	Bank #	Name	EDID Name
<input type="checkbox"/>	1	Bank 1	GEFEN_VPT_S1
<input type="checkbox"/>	2	Bank 2	GEFEN_VPT_S1
<input type="checkbox"/>	3	Bank 3	GEFEN_VPT_S1
<input type="checkbox"/>	4	Bank 4	GEFEN_VPT_S1
<input type="checkbox"/>	5	Bank 5	GEFEN_VPT_S1
<input type="checkbox"/>	6	Bank 6	GEFEN_VPT_S1
<input type="checkbox"/>	7	Bank 7	GEFEN_VPT_S1
<input type="checkbox"/>	8	Bank 8	GEFEN_VPT_S1

Select All Banks

Copy Cancel

Banks

Copy To	Bank #	Name
<input type="checkbox"/>	1	Bank 1
<input type="checkbox"/>	2	Bank 2
<input type="checkbox"/>	3	Bank 3
<input type="checkbox"/>	4	Bank 4
<input type="checkbox"/>	5	Bank 5
<input type="checkbox"/>	6	Bank 6
<input type="checkbox"/>	7	Bank 7
<input type="checkbox"/>	8	Bank 8

Select All Banks

Copy EDID To (Banks)

Place a check mark in the desired check box to select or deselect the desired EDID bank(s).

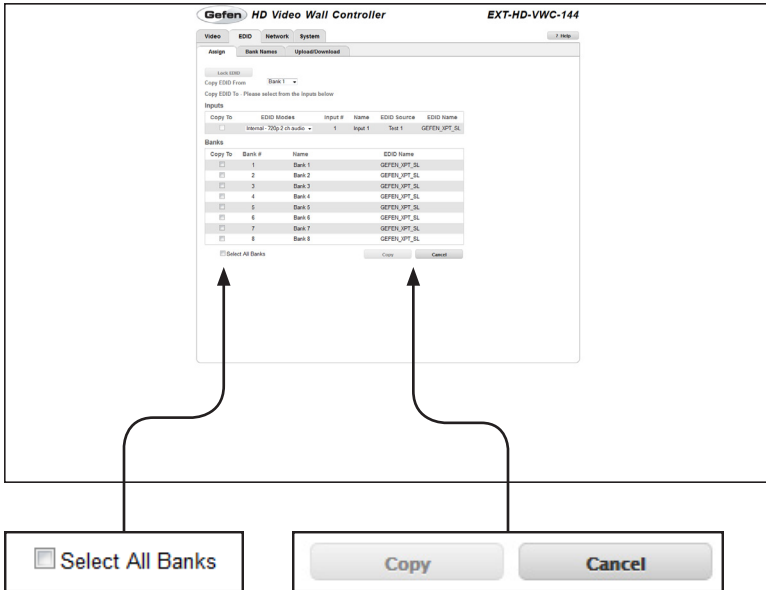

Select All Banks

Place a check mark in the check box to select all EDID banks. Remove the check mark to deselect all EDID banks.

Copy

Click this button to perform the EDID copy operation.

Cancel

Cancels the current operation and ignores changes for each input, if a change was made.

EDID ► Bank Names

The screenshot shows the 'Edit Bank Names' dialog box in the Gefen HD Video Wall Controller web interface. The dialog box is a table with 8 rows, each representing an EDID bank. The columns are 'Bank #' and 'Name'. The 'Name' column contains text input fields, each with 'Bank 1' through 'Bank 8' respectively. Below the table are 'Save' and 'Cancel' buttons. An arrow points from the 'Name' column header to the first input field.

Bank #	Name
1	Bank 1
2	Bank 2
3	Bank 3
4	Bank 4
5	Bank 5
6	Bank 6
7	Bank 7
8	Bank 8

Save Cancel

Bank #

Indicates the EDID bank number.

Name

Type the desired name of the EDID bank in this field.

Save

Saves the current name change to the EDID bank(s).

Cancel

Cancels the naming operation and restores the previous names for each EDID bank.

EDID ► Upload / Download

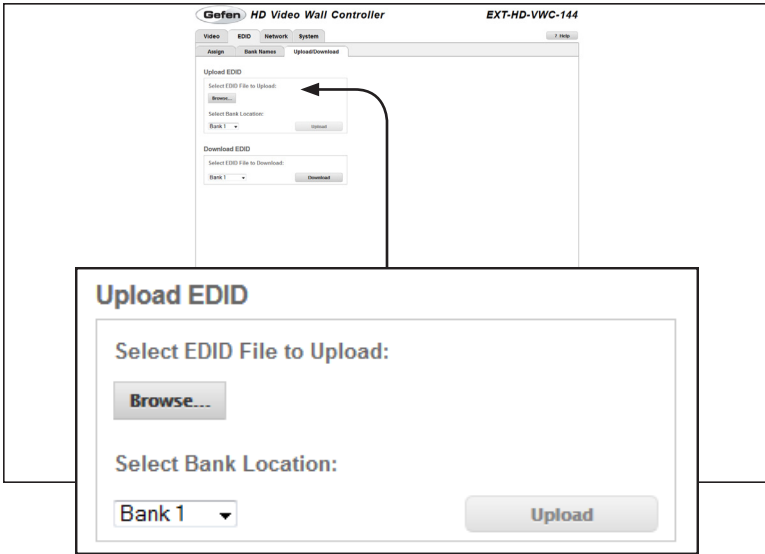

Browse...

Click this button to select the EDID file to be uploaded.

Select Bank Location

Click this drop-down list to select the bank to where the EDID will be uploaded.



Upload

Click this button to upload the EDID to the specified bank.



Select EDID File to Download

Click this drop-down list to select the bank to where the EDID will be uploaded.

Options
Bank 1 ... Bank 8
A - out0Name ... D - out3Name
1 - inputname

Download

Click this button to download the selected EDID to a file.

Network

The screenshot shows the 'Network' configuration page for a Gefen HD Video Wall Controller (EXT-HD-VWC-144). The page has tabs for 'Video', 'EIO', 'Network', and 'System'. The 'Network' tab is active, showing the following settings:

- IP Settings: 00:1C:91:02:80:21
- MAC Address: 00:1C:91:02:80:21
- Mode: DHCP
- IP Address: 192.168.7.73
- Subnet: 255.255.255.0
- Gateway: 192.168.7.254
- HTTP Port: 88

A callout box titled 'IP Settings' provides a detailed view of these fields:

- MAC Address:** 00:1C:91:02:80:21
- Mode:** DHCP (dropdown menu)
- IP Address:** 192.168.7.73
- Subnet:** 255.255.255.0
- Gateway:** 192.168.7.254
- HTTP Port:** 88

Buttons for 'Set Defaults' and 'Save' are located at the bottom of the callout box.

MAC Address

Displays the MAC address of the HD Video Wall Controller. The MAC address cannot be changed.

Mode

Click this drop-down list to select the IP mode. The IP mode must be set to Static in order to make changes to the IP Address, Subnet, and Gateway.

Options
DHCP
Static

IP Address

Enter the IP address in this field.

Gateway

Enter the gateway address in this field.

Subnet

Enter the subnet mask address in this field.

HTTP Port

Enter the HTTP listening port in this field.

Set Defaults

Click this button to restore the factory-default IP settings. After clicking this button, the Web interface will display a dialog indicating that the HD Video Wall Controller must be rebooted for changes to take effect.

Save

Saves the current IP settings. After clicking this button, the Web interface will display a dialog indicating that the HD Video Wall Controller must be rebooted for changes to take effect.

The screenshot shows the 'Gefen HD Video Wall Controller' web interface. The 'System' tab is active, displaying various settings. A 'TCP/Telnet Settings' dialog box is open, with a black arrow pointing from the 'Enable TCP Access' checkbox in the background to the same checkbox in the dialog. The dialog contains the following fields:

- Enable TCP Access:**
- Require Password on Connect:**
- User Name:**
- Old Password:**
- New Password:**
- Confirm New Password:**
- Terminal Port:**

A 'Save' button is located at the bottom of the dialog box.

Enable TCP Access

Place a check mark in the check box to enable Telnet access.

Require Password on Connect

Place a check mark in the check box to force the HD Video Wall Controller to prompt for a password each time a Telnet session is started. This box *must* be checked in order to change the Telnet user name and password.

User Name

Type the user name in this field.

Old Password

Type the current (old) password in this field.

New Password

Type the new password in this field.

Confirm New Password

Confirm the password change by retyping the new password in this field.

Terminal Port

Enter the Telnet listening port in this field.

Save

Saves the current changes to the TCP / Telnet Settings.

The screenshot shows the 'System' tab of the Gefen HD Video Wall Controller web interface. The 'UDP Settings' section is highlighted with a callout box. The settings are as follows:

Setting	Value
Enable UDP Access:	<input checked="" type="checkbox"/>
UDP Port:	21
Enable Remote UDP Access:	<input checked="" type="checkbox"/>
Remote UDP IP Address:	192.168.1.255
Remote UDP Port:	21

A 'Save' button is located at the bottom of the callout box.

Enable UDP Access

Place a check mark in the check box to enable UDP access.

UDP Port

Enter the UDP port in this field.

Enable Remote UDP Access

Place a check mark in the check box to enable remote UDP access.

Remote UDP IP Address

Type the remote UDP IP address in this field.

Remote UDP Port

Type the remote UDP port in this field.

Save

Saves the current changes to the UDP Settings.

System

The screenshot shows the 'System' tab of the Gefen HD Video Wall Controller web interface. The interface includes a navigation menu with 'Video', 'EDD', 'Network', and 'System' tabs. The main content area contains several configuration sections: 'Download Current Configuration' with a 'Download' button; 'Restore Configuration' with a 'Restore' button and a 'Browse...' button; a warning message 'Warning: All current settings will be lost'; 'Firmware Update (UI ver: v1.17)' with an 'Update' button and a 'Browse...' button; 'IR Channel' with a dropdown menu showing '0'; 'Factory Reset' with a 'Reset' button; and 'Reboot' with a 'Reboot' button. A callout box highlights these sections.

Download

This feature will be available in a future release of the software.

Browse... (Restore Configuration)

This feature will be available in a future release of the software.

Restore

This feature will be available in a future release of the software.

Browse... (Firmware Update)

This feature will be available in a future release of the software.

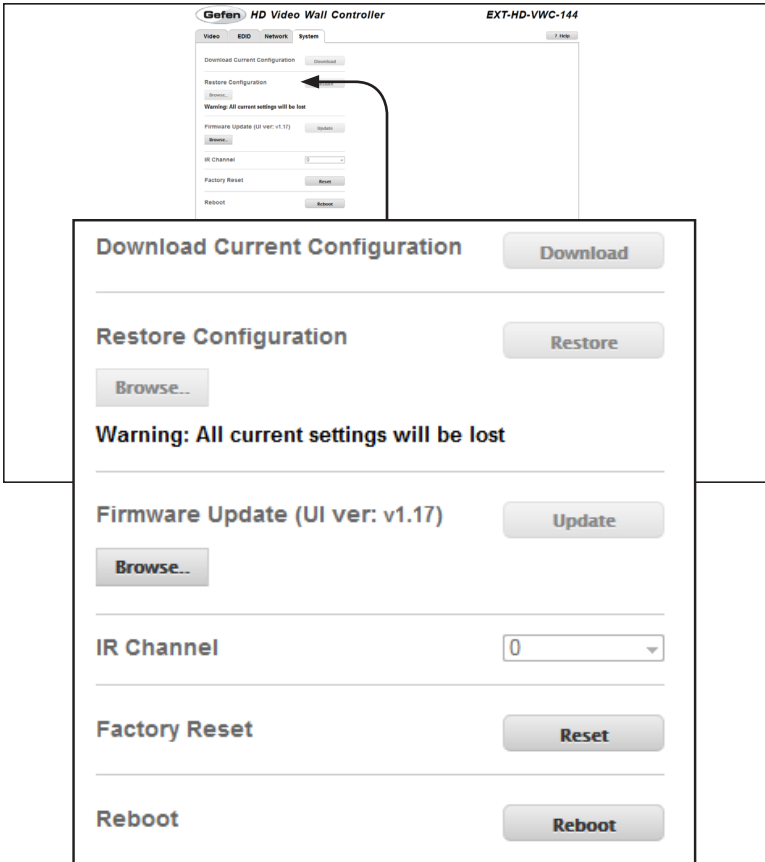

IR Channel

This feature will be available in a future release of the software.

Reset

Click this button to set the matrix to factory-default settings. The IP settings are preserved.

Reboot

Click this button to reboot the matrix.

HD Video Wall Controller

04 Appendix

Upgrading the Firmware.....	112
Using the Web Interface.....	112
Using the USB Interface.....	113
Specifications	114

Upgrading the Firmware

Using the Web Interface



IMPORTANT: *DO NOT* power-off or disconnect the AC power cord from the matrix, at any time, during the firmware upgrade process.

1. Download the firmware update from the Support section of the Gefen Web site.
2. Extract the firmware file from the .ZIP file.
3. Power-ON the HD Video Wall Controller.
4. Connect an Ethernet cable between the matrix and the computer running the Web interface.

It is unnecessary to disconnect any cables or extenders from the HD Video Wall Controller during the update process.

5. Click the **Configuration** tab in the Web interface and click the **Browse...** button under the **System Configuration** section.
6. Select the firmware file and click the **Update** button.
7. The matrix will display a prompt to verify that the current firmware will be overwritten. Click the **OK** button on the dialog box to begin uploading the firmware file.
8. The HD Video Wall Controller will begin the upgrade process. This process will take several minutes. The upgrade process may be monitored using the RS-232 interface.
9. After the HD Video Wall Controller has been updated, the unit will automatically reboot.
10. After the HD Video Wall Controller reboots, the firmware upgrade process will be complete.

Using the USB Interface



IMPORTANT: *DO NOT* power-off or disconnect the AC power cord from the matrix, at any time, during the firmware upgrade process.

1. Download the firmware update from the Support section of the Gefen Web site.
2. Power-ON the HD Video Wall Controller.

Connect a USB cable between the computer and the HD Video Wall Controller.

It is unnecessary to disconnect any cables or extenders from the HD Video Wall Controller during the update process.

3. Once the computer is able to connect to the HD Video Wall Controller, a removable-disk icon will be displayed under My Computer.
4. Extract the firmware file from the .ZIP file and drag the .bin file to the Removable Disk.
5. Disconnect the USB cable from the computer.
6. After the HD Video Wall Controller has been updated, the unit will automatically reboot.
7. After the HD Video Wall Controller reboots, the firmware upgrade process will be complete.

Specifications

Supported Formats

Resolutions (max.)	<ul style="list-style-type: none"> • 1080p Full HD • 1920 x 1200 (WUXGA)
--------------------	--

Electrical

Maximum Pixel Clock	<ul style="list-style-type: none"> • 225 MHz
Menu Button	<ul style="list-style-type: none"> • 1 x Tact-type
Menu Navigation Buttons	<ul style="list-style-type: none"> • 5 x Tact-type
Power Button	<ul style="list-style-type: none"> • 1 x Tact-type
Power Indicator	<ul style="list-style-type: none"> • 1 x LED, multi-color (red / blue)

Connectors

Video Input	<ul style="list-style-type: none"> • 1 x HDMI Type A, 19-pin, female, locking
Video Outputs	<ul style="list-style-type: none"> • 4 x HDMI Type A, 19-pin, female, locking
RS-232	<ul style="list-style-type: none"> • 1 x DB-9, female
IP Control	<ul style="list-style-type: none"> • 1 x RJ-45, shielded
USB (Service only)	<ul style="list-style-type: none"> • 1 x Mini-USB

Operational

Power Input (Sender / Receiver)	<ul style="list-style-type: none"> • 1 x 12V DC, locking
Power Consumption (Sender / Receiver)	<ul style="list-style-type: none"> • 24W (max.)

Physical

Dimensions (W x H x D) (Sender / Receiver)	<ul style="list-style-type: none"> • 16.9" x 1.7" x 7.9" (430mm x 43mm x 200mm)
Unit Weight	<ul style="list-style-type: none"> • 4.8 lbs (2.18 kg)



Stretch It, Switch It, Split It.
Gefen's Got It. ®

20600 Nordhoff St., Chatsworth CA 91311
1-800-545-6900 818-772-9100 fax: 818-772-9120
www.gefen.com support@gefen.com



This product uses UL or CE listed power supplies.